

CARDIO

STRENGTH

FREE WEIGHTS

RIGS & STORAGE

FUNCTIONAL

STUDIO

BOXING

FLOORING

GYM DESIGN

SUPPORT

origin[®]
FITNESS

PRODUCT CATALOGUE 2018



CARDIO

STRENGTH

FREE WEIGHTS

RIGS & STORAGE

FUNCTIONAL

STUDIO

BOXING

FLOORING

GYM DESIGN

SUPPORT

origin[®]
FITNESS



CARDIO



STRENGTH



FREE WEIGHTS



RIGS & STORAGE



FUNCTIONAL



STUDIO



BOXING



FLOORING



GYM DESIGN



SUPPORT

CARDIO

Our range of cardiovascular products aims to cater to the needs of all users in all types of facilities. While traditional CV machines like treadmills, bikes, cross trainers are still a key part of a gym's offering, we have seen increased demand for HIIT cardio products. Items falling into this category include air bikes, rowers, curved treadmills and other unique pieces of equipment.

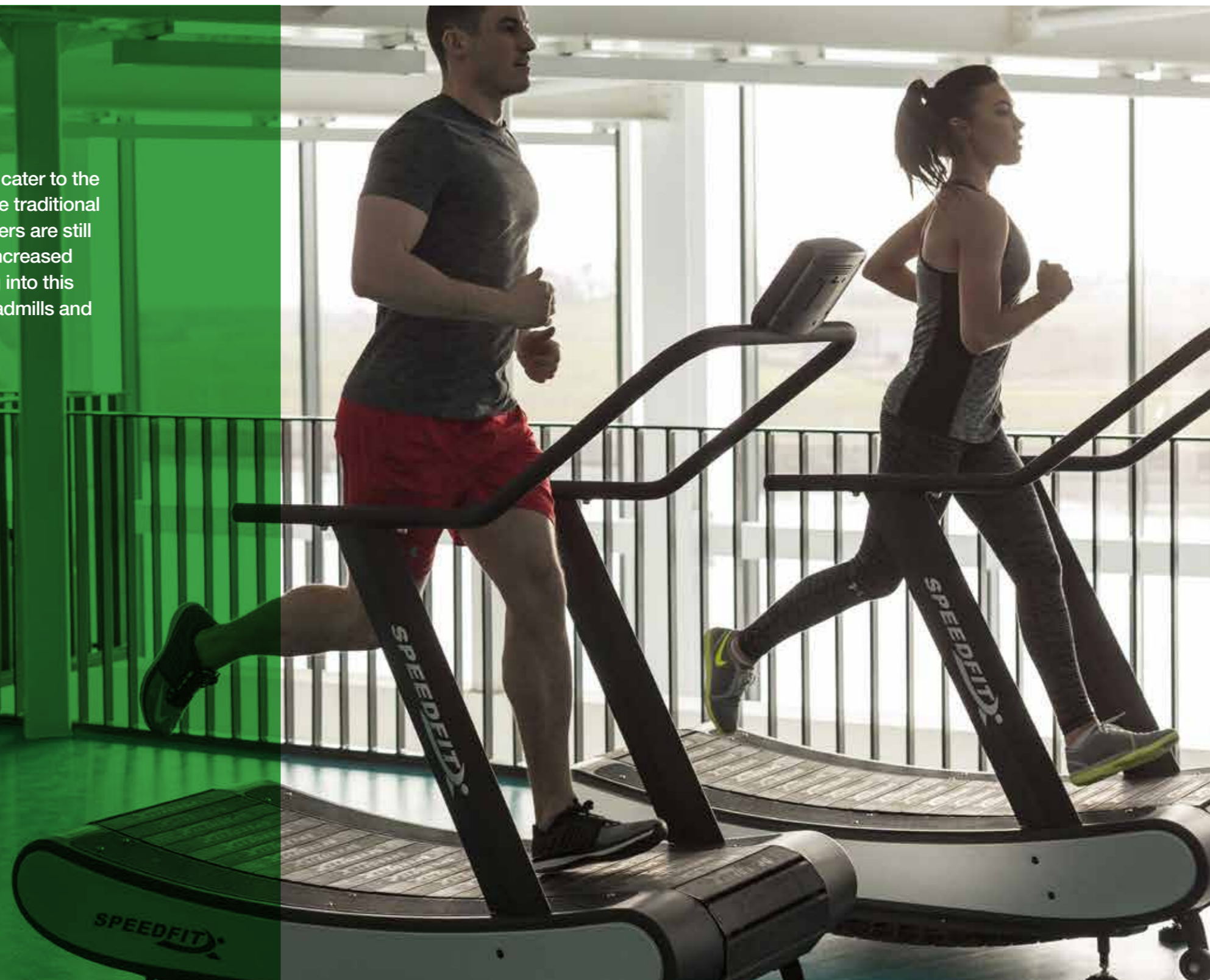
[Intenza Fitness](#)[Impulse Cardio](#)[Indoor Cycles](#)[Star Trac Cardio](#)[Stairmaster HIIT Cardio](#)[HIIT Cardio](#)



INTENZA ENTERTAINMENT SERIES CONSOLE

Experience the latest technology on a beautifully designed and responsive embedded touch screen. With great features for both the user and the gym, you'll never think of cardio equipment the same way.

- Intenzacast (mobile mirroring)
- 19-inch Capacitive Touch Display
- Analogue and Digital TV
- Virtual Scenery - explore beautiful scenery while you exercise
- InCare™ 2.0 via USB

INTENZA INTERACTIVE SERIES CONSOLE

Enjoy straightforward access to all workouts and programming with Intenza's exclusive Uni-Dial Navigation Control™ - simply turn and press a single dial.

- LED Display
- InCare™ 2.0 via USB
- Uni-Dial Navigation Control™
- InZone™ Heart Rate Monitoring
- Digital contact and Polar wireless heart rate monitoring



DIMENSIONS

2150 x 960 x 1540mm

WEIGHT

236kg

PRODUCT CODE	ITEM	PRICE
INT-550Te2	Intenza 550Te2 Treadmill - Entertainment Series	Contact us for a quote
INT-550Ti	Intenza 550Ti Treadmill - Interactive Series	Contact us for a quote

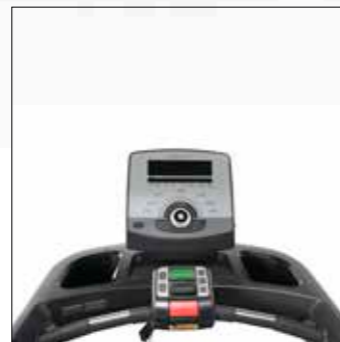

INTENZA 550T SERIES TREADMILLS

Because walking, jogging and running are the most instinctive forms of movement for most people, treadmills find themselves at the heart of many fitness facilities and are widely used by exercisers of all fitness levels.

Awarded 2014 Fitness Tribune Design Award, the 550Te Treadmill has earned the reputation of being high calibre cardio equipment. The 550T Series merges stunning design and smart technology with the entertainment and performance features exercisers demand.

The eye-catching design of the 550T Series blends artistic lines and the long-lasting beauty of aluminium elements with today's must-have technology creating a line of cardio products truly for the 21st Century.

Features

- Intenzacast (mobile mirroring)
- 19-inch Capacitive Touch Display
- Analogue and Digital TV
- Virtual Scenery - explore beautiful scenery from all over the world
- InCare™ 2.0 via USB
- Available with the Entertainment Series Console as well as the Interactive Series Console.

INTENZA 550E SERIES ELLIPTICAL

A good elliptical should be solid, easy to operate and feel natural to use. The 550E itself mimics the body's natural movements smoothly and gracefully while keeping workouts fresh and exciting with a robust offering of custom programs. Connectivity with a variety of tablets and smartphones enables exercisers to listen to their own playlists or watch their favourite shows on the full-colour touchscreen monitor.

Because of their popularity, elliptical trainers receive a great deal of daily use, therefore, must be superbly built. The 550ETi is built to sustain performance and appearance, day in and day out, keeping exercisers satisfied and coming back for more.

Features

- 16-Inch Capacitive Touch Display
- Robust frame structure is engineered for longevity and durability
- Intenzacast (mobile mirroring)
- InCare™ via Internet
- Self-powered, 3-phase, hybrid generator and belt drive system
Belt drive delivers smooth and quiet motion to foot pedals and handlebars
- Available with the Entertainment Series Console as well as the Interactive Series Console.



DIMENSIONS

2090 x 840 x 1720mm

WEIGHT

188kg

PRODUCT CODE	ITEM	PRICE
INT-550ETe2	Intenza 550ETe2 Elliptical - Entertainment Series	Contact us for a quote
INT-550ETi	Intenza 550ETi Elliptical Trainer - Interactive Series	Contact us for a quote

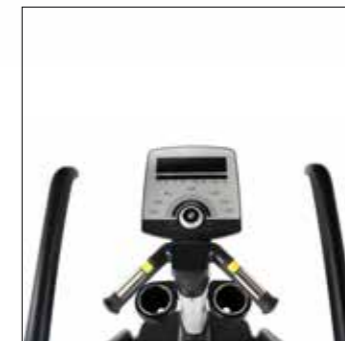

**DIMENSIONS**

1220 x 670 x 1460mm

WEIGHT

70kg

PRODUCT CODE	ITEM	PRICE
INT-550UBe2	Intenza 550UBe2 Upright Bike - Entertainment Series	Contact us for a quote
INT-550UBi	Intenza 550UBi Upright Bike- Interactive Series	Contact us for a quote

INTENZA 550UB SERIES UPRIGHT BIKES

The 550Ube2 merges stunning design and smart technology with the entertainment and performance features exercisers demand.

Biking provides a no—impact workout powered by pedalling, a motion very familiar to many people, making it very easy to perform properly. Also, as our population ages, this form of exercise is an important option for exercise facilities to provide because of its low risk of strain or injury.

Upright exercise bikes allow for a variety of movement, such as riding while standing or in a racing position, so multiple muscle groups can be exercised as a biker changes position. Plus, users with conditions such as spinal stenosis or osteoarthritis may find the forward-leaning position on the upright bike to be most comfortable compared to that of a recumbent bike.

The Intenza 550 UBe is designed for ease of getting on and off the bike, includes precise seat adjustments, and adjusts to 40 resistance levels – the most in the industry.

Features

- Robust frame structure ensures strength and durability
- 154 lbs. (70 kg) total weight provides stable, comfortable workouts
- Mimics the frame height and saddle-style of a road bike.
- Equipped with sturdy wheels allowing safe and easy relocation within the facility
- Available with the Entertainment Series Console as well as the Interactive Series Console.

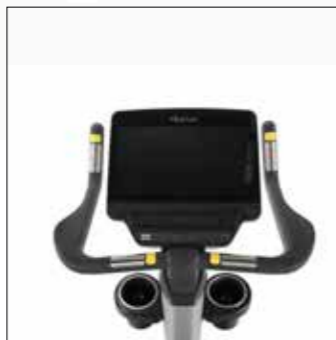

INTENZA 550RB SERIES RECUMBENT BIKES

Recumbent bikes can be ideal for people who struggle with upright bikes. Those with lower back issues, neck pain, reduced neck mobility, or other physical limitations may find recumbent bikes to be a comfortable and sustainable way to maintain their cardio goals. This bike option can also place less stress on wrists and elbows.

The recumbent's step—through design creates a very low-profile seat and frame eliminating the need for exercisers to lift their legs when lowering into the seat. Ideal for those with limited mobility who still desire a cardio workout.

Value comes from strong construction, Simple to use, Easy to maintain. Exercisers find value in those things as well as these: Intuitive controls, comfortable, natural workouts, personalization and program variety.

Features

- Bottom bracket assembly with precision sealed ball bearings sustain, already exceptionally smooth, performance
- Ergonomic seat back designed with ventilation, lumbar support, and saddle provides long-lasting comfort and positioning for even the most rigorous workouts
- Accommodates users weighing up to 181kg (400lbs)
- Incremental seat adjustment accommodates exercisers from heights of 4'9" (147cm) to 6'5" (193cm)
- Available with the Entertainment Series Console as well as the Interactive Series Console.

DIMENSIONS

1600 x 700 x 1240mm

WEIGHT

102kg

PRODUCT CODE	ITEM	PRICE
INT-550RBe2	Intenza 550RBe2 Recumbent Bike - Entertainment Series	Contact us for a quote
INT-550RBI	Intenza 550RBI Recumbent Bike - Interactive Series	Contact us for a quote

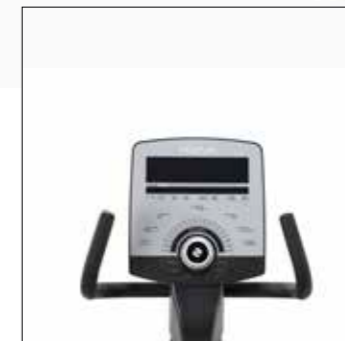

**DIMENSIONS**

1960 x 860 x 2120mm (height 2340mm at max incline)

WEIGHT

331kg

PRODUCT CODE **ITEM****INT-550Ce2** Intenza 550Ce2 Escalate Climber - Entertainment Series**INT-550Ci** Intenza 550Ci Escalate Climber- Interactive Series**PRICE****Contact us for a quote****Contact us for a quote**

INTENZA 550C ESCALATE STEP CLIMBER

For over 20 years, climbing exercisers have been regaled as one of the most efficient ways to build lower body strength and enhance cardio respiratory fitness. The benefits are undeniable, but the target demographic has always been limited. Until now. Introducing the Intenza Escalate 550™ Series, the world's first-ever adjustable-step-height climber.

The Escalate 550™ Series Climber opens up the world of climbing exercise to users at every fitness level. The revolutionary Smart StepHeight Technology allows users to choose between 20 unique step-height variations.

Whether you want to regain joint flexibility post-surgery, ease back into a workout routine, or push yourself to your physical limits, the 550Ce2 lets you fine-tune the intensity of your workout to align with your unique cardiovascular and range-of-motion goals.

Features

- Intenza's Smart StepHeight technology means users can choose between 20 unique step-height options.
- Produced with our planet and our employees in mind, the Escalate 550 Series Climber meets ErP standards and gives peace of mind to end users and facilities alike.
- Provides proactive machine diagnostics via Wi-Fi connection, allowing real-time updates and alerts.
- Available with the Entertainment Series Console as well as the Interactive Series Console.



IMPULSE RT500 TREADMILL

This treadmill boasts a rust-resistant undercoat and a reversible deck allowing for a greater life span of the components. The maximum user weight this machine can take is 180kg and it is capable of an incline up to 15 degrees. The wide running surface of 22", and the quiet operation, gives the user confidence on the machine, and the low profile (step height of only 8.5") makes it accessible to a more extensive demographic.

Features

- Impact absorption system provides the superior feel for all users, reversible deck for longer life time
- Operation noise as low as 73 db
- 12 Workout options
- 22" wide running area
- Max Speed 20km/h (12mph)
- Incline Range of 0-15%



Feature rich treadmill console



Wide 22" running deck

DIMENSIONS

2078 x 878 x 1500mm

WEIGHT

195kg

PRODUCT CODE	ITEM	PRICE
IF-RT500	Impulse RT500 Treadmill	£5,040.00



12 Pre-programmed workouts



On your finger-tips incline & speed control

IMPULSE RT700 TREADMILL

This treadmill boasts a rust-resistant undercoat and a reversible deck allowing for a greater life span of the components. The maximum user weight this machine can take is 200kg and it is capable of an incline of up to 15 degrees.

The wide running surface of 22", and the quiet operation, gives the user confidence on the machine, and the low profile (step height of only 8.5") makes it accessible to a more extensive demographic.

- Wide 22" reversible running deck
- Pulflex™ commercial cushioning system
- Quick controls, fan and contact heart-rate on ergonomic handle bars
- Max Speed 25kph (15mph)
- Incline Range of 0-15%

PRODUCT CODE	ITEM	PRICE
IF-RT700	Impulse RT700 Treadmill	£5,499.08

DIMENSIONS	WEIGHT
2078 x 878 x 1500mm	195kg

IMPULSE RE500 ELLIPTICAL CROSS TRAINER

The Impulse RE500 boasts a 21" stride length with optimised positions fine-tuned for natural, smooth movement. The low 7" step on height makes the RE500 very accessible and the oversized pedals, make this elliptical trainer comfortable and safe, as well as effective.

- Eleven workout modes
- LED display with workout read-outs and heart rate
- Two step powder-coating with rust-resistant undercoat
- Self powered hybrid brake
- Twenty levels of resistance



LED display with workout read-outs and heart rate



Oversized pedals

DIMENSIONS

2108mm x 675mm x 1686mm

WEIGHT

120kg

PRODUCT CODE	ITEM	PRICE
IF-RE500	Impulse RE500 Elliptical Cross Trainer	£3,665.75

IMPULSE RE700 ELLIPTICAL CROSS TRAINER

The Impulse[®] RE700 Elliptical has 21" stride Length with twenty levels of resistance that will challenge users of all fitness levels. The console is simple and easy to use and features twelve Workouts, as well as Polar[®] Contact, telemetry and Ergonomic Contact Heart-Rate Handles.

- Eleven workout modes
- Seven windows dot matrix LED display
- Twenty levels of resistance
- Personal cooling fan
- Oversized pedals and narrow spacing make for a comfortable workout
- 21" stride length
- 160kg maximum user capacity
- Button display or touch buttons on stationary handlebars



Eleven workout modes



Oversized pedals

DIMENSIONS

2108mm x 675mm x 1688mm

WEIGHT

140kg

PRODUCT CODE	ITEM	PRICE
IF-RE700	Impulse RE700 Elliptical Cross Trainer	£4,582.41

IMPULSE RR500 RECUMBENT BIKE

Full of features including twenty resistance and eleven programmed workouts. The Impulse[®] RR500 Commercial Exercise Bike is comfortable and easy to use, making it perfect for your healthclub.

- Three riding positions for handlebars with contact heart rate grips on-your-finger-tips control
- Two-step powder-coating with rust-resistant undercoat
- Wheels on front for ease of movement of equipment
- Self powered hybrid brake
- Clear LCD screen



Contact heart rate monitoring on handlebars



12 Console workout options

DIMENSIONS

1650 x 650 x 1370mm

WEIGHT

84kg

PRODUCT CODE	ITEM	PRICE
IF-RR500	Impulse RR500 Recumbent Bike	£2,290.75

IMPULSE RR700 RECUMBENT BIKE

The RR700 comes with 450W commercial level brakes, extra wide dual sided pedals with easy adjustable straps. The optimized Q factor (distance between pedals) reduces the force on the knees and makes each pedal stroke more efficient. The ergonomic handles with fast track controls allows you to easily adjust the resistance.

- Three riding positions for handlebars with contact heart rate grips on-your-finger-tips control
- Two-step powder-coating with rust-resistant undercoat
- Wheels on front for ease of movement of equipment
- Self powered hybrid brake
- Clear LCD screen



Console quick keys for resistance



Oversized pedals for comfort and ease of use

DIMENSIONS

1650 x 650 x 1370mm

WEIGHT

84kg

PRODUCT CODE	ITEM	PRICE
IF-RR700	Impulse RR700 Recumbent Bike	£2,749.08

IMPULSE RU500 UPRIGHT BIKE

Loaded with seven different workout options and twenty resistance levels, the RU500 is a member of one of the most ergonomically designed families of uprights and features three handle positions, integrated button controls and extra wide pedals.

The metal components have a two-step powder coating with a rust resistant undercoat making them more resilient to wear.

- Single sided weighted pedals
- Three comfortable handles positions
- Ergonomic seat design
- 160kg maximum user capacity



12 Console workout options

DIMENSIONS

1090 x 660 x 1490mm

WEIGHT

67kg

PRODUCT CODE ITEM

IF-RU500

Impulse RU500 Upright Bike

PRICE

£2,061.58



Contact heart rate monitoring on handlebars



Console quick keys for resistance

IMPULSE RU700 UPRIGHT BIKE

- Extra wide, dual-sided pedals with adjustable straps
- Ergonomic handles with quick controls to adjust the resistance
- Wheels on front for ease of movement
- Polar contact for heart rate and telemetry

DIMENSIONS

1090 x 660 x 1490mm

WEIGHT

67kg

PRODUCT CODE	ITEM	PRICE
IF-RU700	Impulse RU700 Upright Bike	£2,474.08

BODELWYDDAN CASTLE WARNER HOTELS



Working with Origin Fitness was a quick and easy process from start to finish. Our account manager Kenny offered some really valuable support and advice throughout the project and we're absolutely delighted with the end result. ”

Adam Roberts
Fitness Manager
Warner Hotels



ORIGIN OC3 INDOOR CYCLE

The OC3 indoor cycle offers unrivalled value, with the perfect combination of top end specifications and a realistic road bike feel.

This bike is guaranteed to deliver performance, reliability and affordability for your home gym or fitness facility. Even as the OC range entry level bike, it comes with our full Origin commercial warranty.

- 21kg perimeter weighted flywheel.
- Narrow Q-Factor for a realistic road bike feel.
- Lightweight, rust resistant aluminium seat and handlebar posts.
- Height adjustable handlebars with bottle holder to help keep you hydrated.
- Realistic chain drive mechanism and dual-sided pedals (toe cage and SPD).

Dimensions: L1165mm x W563mm x 1156mm
 Weight: 57kg
 Max User Weight: 160kg
 Gear Ratio: 3.25:1
 Q-Factor: 165mm
 User Compatible Size: 145cm - 200cm

PRODUCT CODE	ITEM	PRICE
OF-OC3	Origin OC3 Indoor Cycle	£732.41



ORIGIN OC5 INDOOR CYCLE

Shift your indoor cycling up a gear with the Origin OC5 Indoor Cycle. This full commercial indoor exercise bike is packed with features that provide a high quality ride that's comfortable, robust and exceptional value

- 21kg perimeter weighted flywheel.
- Smooth and quiet, low maintenance belt drive mechanism.
- Narrow Q-Factor of 165mm helps to replicate road cycling.
- Height adjustable handlebars and seat including adjustable fore and aft.
- Handlebars include double water bottle holder to help you workout for longer.

Dimensions: L1165mm x W563mm x 1156mm
 Weight: 57kg
 Max User Weight: 160kg
 Gear Ratio: 4.3:1
 Q-Factor: 165mm
 User Compatible Size: 145cm - 200cm

PRODUCT CODE	ITEM	PRICE
OF-OC5	Origin OC5 Indoor Cycle	£915.75

ORIGIN INDOOR CYCLE COMPUTER

This computer attaches to the handlebars of any indoor cycle and wirelessly connects to the sensor that is attached to the crank to give cadence (RPM) feedback. For heart rate feedback a heart rate strap must be purchased separately.



PRODUCT CODE	ITEM	PRICE
IF-PS300-PC-HR	Origin Indoor Cycle Computer w/ Heart Rate	£108.90



WEST COAST FITNESS

“

Origin has a great team who are extremely knowledgeable in this field. They had the ability to share our vision for the facility and translate this into a functioning, top class facility. A great measure of a company's success is the ability to keep existing clients. Needless to say, West Coast Fitness will be working with Origin Fitness for many years to come!

”

Simon Marshall
Owner
West Coast Fitness

WATTBIKE

The Wattbike is like no other exercise bike and unparalleled in giving accurate feedback on power output, technique, heart rate, speed, distance, cadence and a variety of other metrics. Developed with British Cycling, the Wattbike helps users get the most out of their workout – whether they're newcomers or Olympic athletes.

- Dual braking system
- Wattbike Performance Computer has a powerful list of features
- Developed with coaches and scientists
- Replicates the sensation of 'real' cycling
- The World's FIRST factory calibrated indoor bike

PRODUCT CODE	ITEM	PRICE
WBL-WT	Wattbike Trainer	£2,117.50
WBL-WBP	Wattbike Pro	£2,117.50



STAR TRAC 8 SERIES TREADMILL

When designing the new 8-TRx, we started with the most solid foundation you could have – more than 20 years of treadmill superiority. And while most would have been content in making subtle improvements to an already proven design, we set out to create the ultimate marriage of user experience, benefits, desires and features ever put under foot. The result is nothing short of impressive

- Easily accessible Hot Bar® is located closer to the user with one finger speed and elevation controls, integrated stop button and contact heart rate grips.
- Star Trac Coach® provides over 1 million possible workouts ensuring a different workout, every time.
- Soft Trac® triple cell cushioning system provides maximum shock absorption making the entire deck a sweet spot.
- 20% max incline | 15 mph max speed.
- Lighter weight aluminium frame.

PRODUCT CODE	ITEM	PRICE
CHF-9-9204-8TRX-220CE-LCDQ-KM	StarTrac 8 Series Treadmill - LCD Screen	£9,898.00
CHF-9-9204-8TRX-220CE-15-PAL	Star Trac 8 Series TRx Treadmill - 15" Touch Screen	£12,098.90



LCD console



15" touch screen console



Media holder

STAR TRAC 8 SERIES UPRIGHT BIKE

A gym standard that looks, feels and rides like anything but one. Take a classic, reliable standby category and give it a healthy dose of reliability, style and energy - that's what you will find with each and every one of the Star Trac upright bikes.

- Dual platform pedals with ratcheting straps provide user with option for secure hold or strap-free platform workout
- Dynamic Heart Rate Control[®] adjusts intensity level based on the user's heart rate for interval training
- Easy-up seat adjust for simple seat position changes
- Morse taper bottom bracket and pedal system for extreme durability
- Lightweight aluminium frame for maximum corrosion protection

PRODUCT CODE	ITEM	PRICE
CHF-9-8120-8UB-LCD	Star Trac 8 Series Upright Bike - LCD Screen	£5,498.90
CHF-9-8120-8UB-15-PAL	Star Trac 8 Series Upright Bike - 15" Touch Screen	£7,698.90



LCD console



15" touch screen console



Media holder



LCD console



15" touch screen console



Media holder



STAR TRAC 8 SERIES RECUMBENT BIKE

Easy and comfortable. How do you improve on an already great recumbent bike experience? You make it as comfortable as a great chair. You start by making sure it features the same Morse Taper bottom bracket and pedal system that is unique to Star Trac bikes. That's exactly what Star Trac did. Then, they kept going with a modern iconic design offering the industry's most comfortable back rest, a walk-through frame design, heart rate bar and adjustable reading station, dual-platform pedals and Star Trac's signature personal fans. The result– a recumbent bike that's the coolest looking and feeling ride on the floor.

- Dual platform with ratcheting straps provide users with the option for a secure hold or a strap-free platform workout
- Star Trac's popular personal fans create a more rewarding workout
- Improved shroud design to ease service
- Armrests alleviate tension in the shoulders and allow for a more relaxed posture
- Telescoping hand grips adjust to fit every user and allow access to the contact HR.

PRODUCT CODE	ITEM	PRICE
CHF-9-8130-8RB-LCD	Star Trac 8 Series Recumbent Bike - LCD Screen	£6,048.90
CHF-9-8130-8RB-15-PAL	Star Trac 8 Series Recumbent Bike - 15" Touch Screen	£8,248.90



LCD console



15" touch screen console



Media holder



STAR TRAC 8 SERIES REAR DRIVE ELLIPTICAL CROSS TRAINER

Elliptical training has become second only to treadmill training in facilities across the globe and it has become one of the most important cardio categories in the eyes of many clients. When designing our 8-Series Rear Drive Elliptical, we wanted to create a comfortable and natural stride pattern, while offering user-centric safety features and the industry's best entertainment solutions.

- Ergonomic hand grips offer multiple hand positions and HR detection.
- Convenience features like water bottle holders, a media shelf, personal fans & optional tablet holder.
- Articulating foot pads & 18" stride length create a very comfortable and natural stride pattern.

PRODUCT CODE	ITEM	PRICE
CHF-9-6150-8RDE-LCD	Star Trac 8 Rear Drive Elliptical Cross Trainer - LCD Screen	£8,798.90
CHF-9-6140-8CT-15-PAL	Star Trac 8 Rear Drive Elliptical Cross Trainer - 15" Touch Screen	£10,998.90

STAR TRAC 8 SERIES TREADCLIMBER

The Star Trac 8 series TreadClimber is unlike any other, the uneven deck provides the opportunity to burn twice as many calories as you would when walking on an original flat treadmill, the uneven deck also protects impact on joints and ankles. The TreadClimber offers an unparalleled improvement in lower body and coordination.

- Specifically designed to maximize caloric burn
- Easily accessible Hot Bar with one-finger speed and level control
- Treadle belt width - 132 x 23cm
- Star Trac's popular personal fans create a more comfortable workout

PRODUCT CODE	ITEM	PRICE
CHF-9-9214-8TC-220CE-LCD	Star Trac 8 Series TreadClimber - LCD Screen	£9,898.90
CHF-9-9214-8TC-220CE-15-PAL	Star Trac 8 Series TreadClimber - 15" Touch Screen	£12,098.90



LCD console



15" touch screen console



Media holder

WEST DUNBARTONSHIRE LEISURE

“

In our view Origin Fitness are the market leaders in providing a one stop shop for the supply and design of gyms. Without hesitation we would recommend Origin Fitness to anyone thinking about refurbishing their gym.

Pauline Raeside
Fitness Manager
West Dunbartonshire Leisure

”

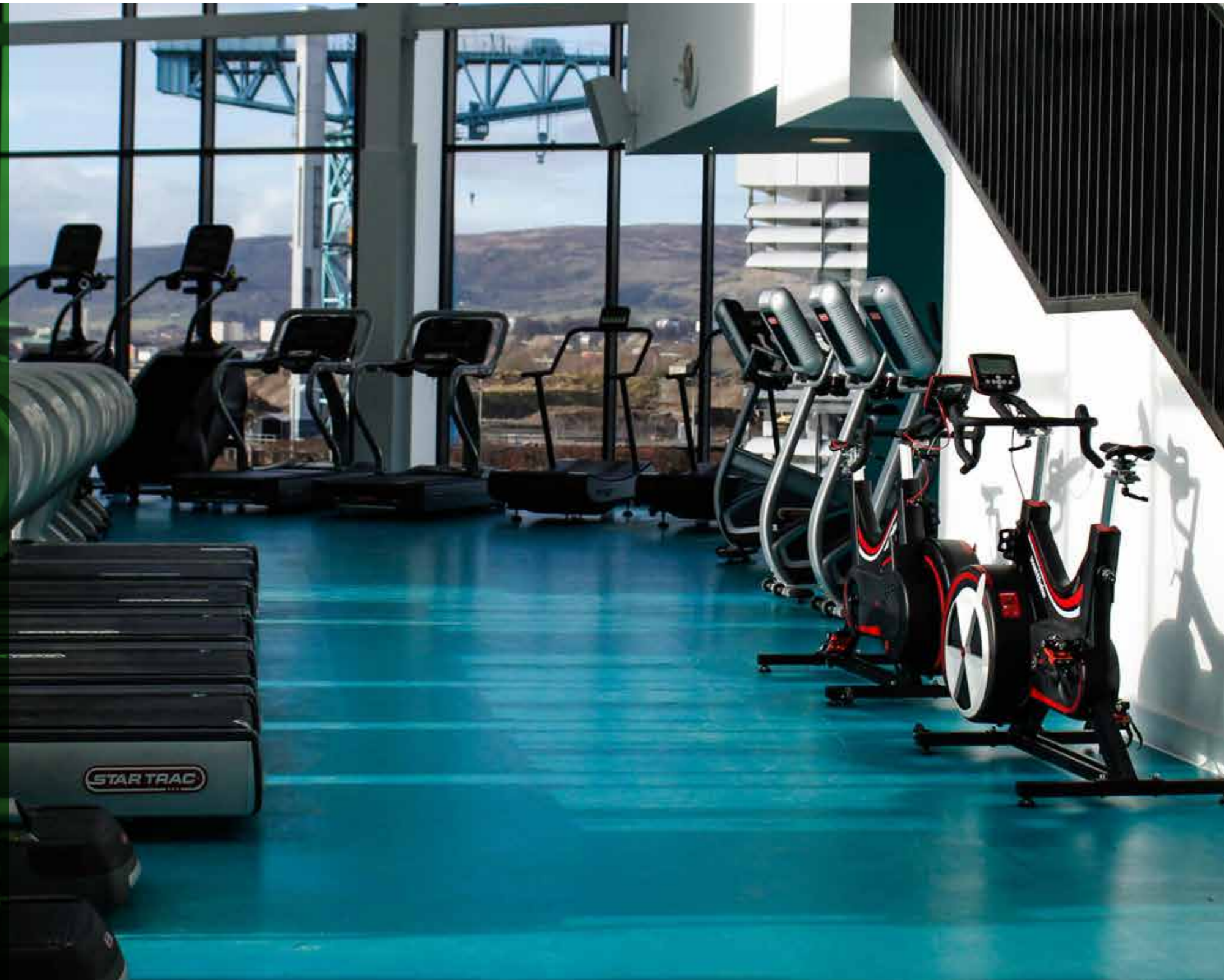

STAIRMASTER 8 SERIES GAUNTLET

Beginning with the first stepping machine in 1983, StairMaster[®] has been a legendary name in the gym. Today the tradition continues with the Gauntlet[®]. Building on 30 years of experience and proven performance, the Gauntlet provides a superior combination of cardio and strength training in our most comfortable design ever. The machine features a deeper, wider step surface with durable, rust-free polypropylene construction and is now available with all three smart, affordable, flexible, OpenHub[™] console options. Its combination of quality and innovation delivers a workout that's head and shoulders above anything else in the gym.

- Available with a variety of OpenHub[™] Options
- Step-up assist for easy mount or dismount
- Hot bar for remote stop and contact heart rate

PRODUCT CODE	ITEM	PRICE
CHF-9-5250-8G-LCD	Stairmaster 8 Series Gauntlet - LCD Screen	£7,698.90



LCD console



15" touch screen console



Media shelf

STAIRMASTER 8 SERIES FREECLIMBER

Decades after pioneering the toughest workout in the gym, StairMaster machines are still the ones members choose to push themselves to the limit. The 8 series FreeClimber™ builds on StairMaster's 30-year reputation of performance and comfort to offer the most innovative climber experience in the gym. The FreeClimber step design includes added cushion and independent pedal geometry, with four-bar linkage to create a fluid, natural stepping motion. OpenHub™ offer's solutions for all of your entertainment, fitness tracking and asset management needs. It's the combination of quality and innovation that provides users with the machines that make hearts pound, lungs burn and keep members coming back to the workouts they love to hate.

- Supplied with LCD Screen and OpenHub™ accessibility
- Ergonomic handrail design reduces impact and comes with contact heart rate grips
- Convenience features like a media shelf, water bottle holders, personal fans & optional tablet holder
- Added cushion and independant pedal geometry to create a fluid, natural spetting motion
- Combination of quality and innovation that make hearts pound

PRODUCT CODE	ITEM	PRICE
CHF-9-5260-8FC-LCD	Stairmaster 8 Series Freeclimber - LCD Screen	£ 7,698.90
CHF-9-5260-8FC-15-PAL	Stairmaster 8 Series FreeClimber - 15" Touch Screen	£ 8,798.90



LCD console



15" touch screen console



Media shelf

STAIRMASTER AIRFIT UB

When it comes to discipline and perseverance, few workouts will challenge you more than those on the Upper Body Ergometer. Whether used in a rehabilitation environment or high performance fitness center, the AirFit UB's adjustable tower, convertible crank arms and comfortable grips let you tailor the workout with the right range of motion for your shoulders, back, wrists, and elbows. An optional ramp and removable bench allows wheelchair access and meets ADA criteria.

- Adjustable tower accommodates a wide variety of workouts & user sizes
- Integrated bench for seated workouts can be removed to accommodate standing or wheelchair workouts
- Feature-rich LED console provides user feedback with a compact, easy to read display
- Adjustable cranks for varied range of motion and bilateral or unilateral motion

PRODUCT CODE	ITEM	PRICE
CHF-AIRFIT-UBE	StairMaster AirFit UB Upper Body Ergometer	£3,463.85



Feature-rich LED console



Adjustable tower accommodates a wide variety of workouts & user sizes

STAIRMASTER AIRFIT

The name recognised for some of the most demanding workouts in the gym now has a new workout your members will love to hate. Tested to withstand 1400 lbs of force, the StairMaster® AirFit™ offers a robust design and features dual action wind resistance that provides a total body cardio workout. The AirFit is designed to push you past your breaking point and keep working long after you can't.

- Dual action wind resistance provides a total body workout
- Feature-rich LED console provides user feedback with a compact, easy to read display
- Robust heavy-gauge welded steel construction
- Backed by a full commercial warranty

PRODUCT CODE	ITEM	PRICE
CHF-160003	Stairmaster AirFit	£1,318.90



Dual action wind resistance



Oversized, easy access pedals



Fore and aft adjustable saddle

STAIRMASTER HIITMILL™ & HIITMILL X

These High-Intensity machines deliver an effective resistance training platform that captures the benefits of speed and agility training, lateral training and sled training. Users can now push, drive and sprint with the resistance of a sled, safely and with a smaller footprint. These easy to use tools allow users to drive up metabolic intensity and make for a more space efficient solution to alternative training methods. Gear up for one tough and rewarding HIIT workout that members will love to hate.

- Multi-grip hand positioning with water bottle and phone holder
- Magnetic resistance brake with resistance control lever
- Extra-wide 23" belt width for lateral training and max stability under load
- The Hiitmill X comes with farmers carry lift arms and 3mm cushioned turf belt for added durability and grip



PRODUCT CODE	ITEM	PRICE
CHF-9-4590-BINTPO	Stairmaster Hiitmill	£3,665.75

PRODUCT CODE	ITEM	PRICE
CHF-9-4640-BINTPO	Stairmaster Hiitmill X	£4,582.42

SPEEDFIT CURVED TREADMILL

The SpeedFit's new way of running helps you burn fat and calories faster and more efficiently than any other fitness concept to date with its innovative toe running approach. It is the same basic concept used in the training of a sprinter for a 100, 200, 400 meter dash. Landing on the ball of your feet pushes your body forward and uses more muscle groups at one time than the traditional heel strike first method used by many runners.



- No bounds, no controls, just get on and run.
- No electricity required – Completely powered by the user.
- Reduces joint impact and improves running performance.
- Innovative curved treadmill design conforms better to your stride.
- Smooth and quiet belt drive system with zero maintenance requirements.

PRODUCT CODE	ITEM	PRICE
TB1-SPT100C	Speedfit Curved Treadmill	£6,598.90



CYBEX SPARC

Lose fat. Build muscle. Gain strength. Increase metabolism. Improve power. SPARC does it all, more safely, because it's biomechanically refined – providing exceptional results with low stress. The SPARC is ideal for adding to your functional, suspension and training zones as well as adding something new to boot camp, cross training and other small group classes. Biomechanically engineered to be gentler on joints, the product encourages users to work harder by minimising their perceived exertion.

- Fan as primary resistance
- Two modes of operation: Circuit Mode & Interval Mode
- Manually controlled incline set at three positions
- Uniquely designed to reduce strain on knees
- Additional resistance mechanism offers resistance at slower strides

PRODUCT CODE	ITEM	PRICE
CYB-SPARC-50A1QR	Cybox Sparc	£4,417.60



ORIGIN OUB1 UPPER BODY TRAINER

- Automatic Magnetic Resistance System
- Can be wall mounted or freestanding
- Comfortable, sweat-proof handles
- 15 Workout Programs
- Built in heart rate belt receiver



Automatic Magnetic Resistance System



15 Workout Programs

PRODUCT CODE	ITEM	PRICE
OF-SK1000-UK049	Origin OUB1 Upper Body Trainer	£624.17
OF-SK1000-FLOOR STAND-UK049	Origin OUB1 Upper Body Trainer - Floor Stand	£83.33
OF-SK1000-WALL MOUNTING-UK049	Origin OUB1 Upper Body Trainer - Wall Mounting Set	£16.67
ATTACHMENTS		
PRODUCT CODE	ITEM	PRICE
OF-SK1000-PULL BAR-UK049	Origin OUB1 Upper Body Trainer - Pull Bar	£22.00
OF-SK1000-OAR BAR-UK049	Origin OUB1 Upper Body Trainer - Pro Oar Bar	£33.00

ORIGIN OR1 ROWING MACHINE

- Full commercial grade rowing machine (non-folding)
- Self generating power
- Heavy duty frame construction with aluminium rails
- Easily adjustable tilting foot rests provides a comfortable workout for any size of user.
- Heart rate programs that will alter resistance or target strokes based on your heart rate



PRODUCT CODE	ITEM	PRICE
OF-RX100-UK049	Origin OR1 Rowing Machine	£707.50

CONCEPT2 ROWING MACHINE

The Concept2 Rower has been the industry's leading rowing machine for many years. Concept2 Rowers give feedback on distance, speed, time, power and calories burned. Rowing offers a full body workout so is considered one of the most intense and gruelling forms of cardiovascular exercise.

- The PM5 Performance Monitor contains an "ANT" chip for wireless communication with ANT heart rate equipment, and also for PC-less racing and future communications with a PC
- Automatic Operation: Just start to row and the monitor turns on and gives feedback. You don't have to push a single button
- LogCard: Removable LogCard stores workout data and personal preferences. A LogCard is included with every PM5
- Supports Machine to Machine Racing: has the computing power to support both wireless and wired racing. No PCs needed



PM5 Performance Monitor

DIMENSIONS

240cm x 60cm

WEIGHT

28kg

PRODUCT CODE	ITEM	PRICE
CN2-2712	Model D with PM5 Monitor	£995.00

JACOBS LADDER

Jacobs Ladder is a patented commercial cardio machine specifically designed for fitness enthusiasts, athletes and professionals and is one of the key pieces of fitness equipment used on “America’s Biggest Loser”.

Its unique design places the user at a 40° angle in order to take stress off of the lower back. Because Jacobs Ladder is self-paced, the faster you go, the faster it goes, in order to stop, just slow down. Jacobs Ladder is also self-powered, so without the need for an electrical outlet, you can place it anywhere in your facility.

- Choose your own pace - The faster you go, the faster the machine works.
- Self powered generator system - No need to use electrical outlet.
- 40 degree workout angle - Ideal for rehab from lower body and back injuries.
- Low impact workout - Less stress on joints when compared to other cardio machines.
- Feedback of elapsed time, feet climbed, speed and calories burnt through digital display.

PRODUCT CODE	ITEM	PRICE
NAF-JL	Jacobs Ladder	£6,249.00





VERSACLIMBER SPORT

The Versaclimber Sport provides the ultimate climbing-style training regime, designed to continuously engage both the upper and lower body in a zero-impact, high calorie burning workout.

- Ideal for athletes and sports people
- Fully adjustable resistance
- Small footprint
- Intelligent console
- High calorie burner
- Hi-Tri compatible

PRODUCT CODE	ITEM	PRICE
VC-SPORT	Versaclimber Sport	£3,995.00

STRENGTH EQUIPMENT

Continuing growth in the popularity of strength training in all different types of gym has pushed Origin Fitness to develop our strength equipment offering to cater for all eventualities. From fixed resistance machines to plate loaded and cables options right through to benches, racks and platforms – we're confident we have your strength training needs covered.

[Fixed Resistance Machines](#)

[Plate Loaded Machines](#)

[Dual Function Machines](#)

[Cable Machines](#)

[Cable Attachments](#)

[Benches, Racks & Platforms](#)

IMPULSE IT95 RANGE

We're delighted to announce the addition of Impulse's premium IT95 Fixed Resistance Range to the Origin Fitness product offering. The IT95 line features improved biomechanics, various weight stack options and multiple component upgrades making it the best Impulse strength range to date.

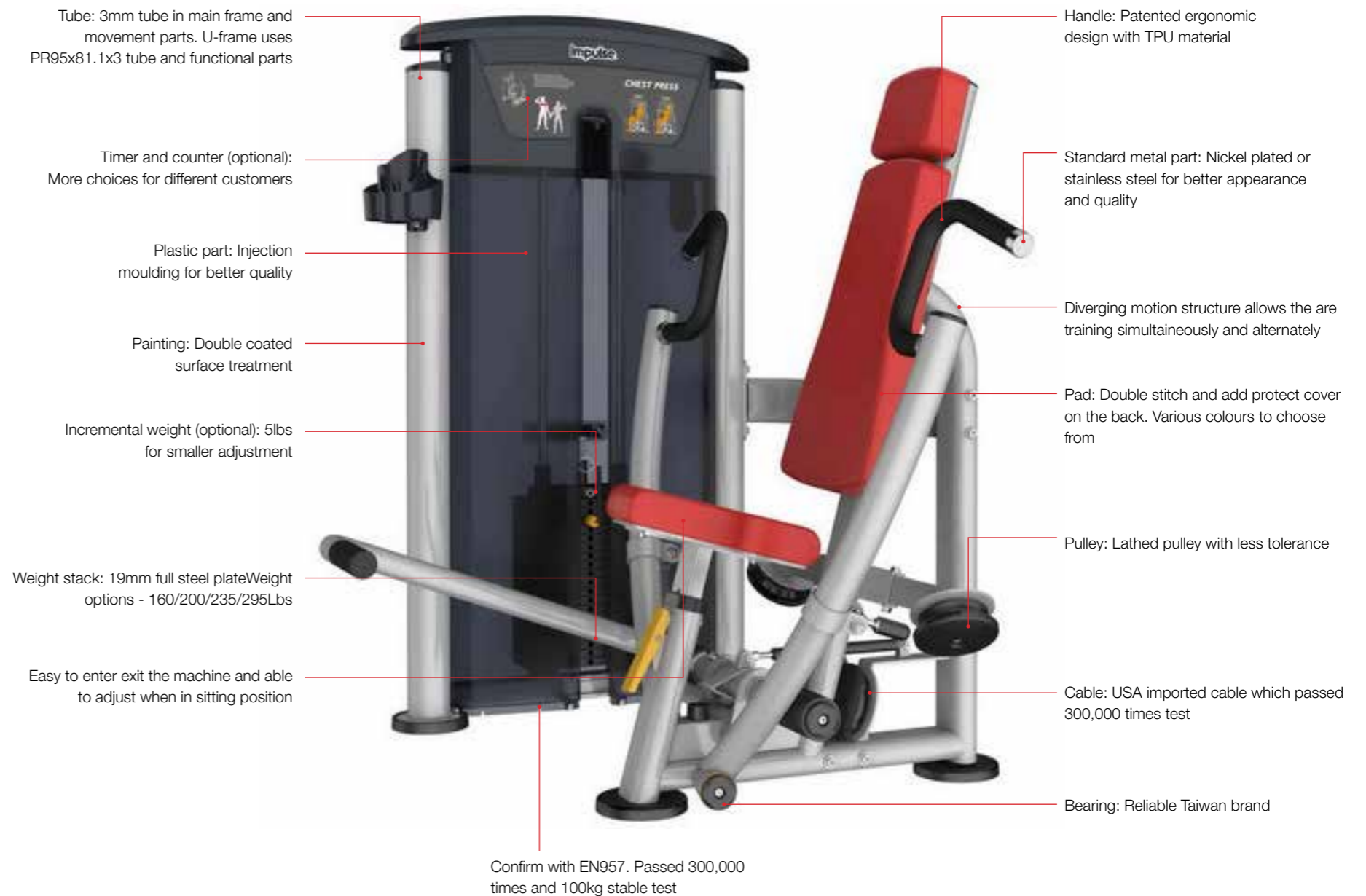

IMPULSE IT95 RANGE



IT9501 Chest Press

Dimensions (LxWxH): 1475x1200x1506mm



IT9502 Lat Pulldown

Dimensions (LxWxH): 1437x1380x1889mm



IT9503 Arm Curl

Dimensions (LxWxH): 1295x1208x1506mm



IT9504 Pectoral

Dimensions (LxWxH): 1460x1360x1506mm



IT9505 Leg Extension

Dimensions (LxWxH): 1202x1189x1506mm



IT9506 Seated Leg Curl

Dimensions (LxWxH): 1536x1186x1506mm



IT9508 Abductor/Adductor

Dimensions (LxWxH): 1555x900x1506mm



IT9510 Leg Press

Dimensions (LxWxH): 1800x1200x1505mm

IMPULSE IT95 RANGE



IT9512 Shoulder Press

Dimensions (LxWxH): 1560x1443x1510mm



IT9514 Abdominal

Dimensions (LxWxH): 1346x1148x1581mm



IT9517 Dip Press

Dimensions (LxWxH): 1694x1234x1506mm



IT9519 Vertical Row

Dimensions (LxWxH): 1622x1300x1506mm



IT9521 Prone Leg Curl

Dimensions (LxWxH): 1443x1146x1506mm



IT9532 Back Extension

Dimensions (LxWxH): 1233x1188x1506mm

PRODUCT CODE	ITEM	PRICE
IF-IT9501	Impulse IT95 Chest Press - with 295lb weight stack	£3,232.50
IF-IT9502	Impulse IT95 Lat Pulldown - with 200lb weight stack	£2,948.39
IF-IT9503	Impulse IT95 Arm Curl - with 160lb weight stack	£2,462.25
IF-IT9504	Impulse IT95 Pectoral - with 200lb weight stack	£2,964.18
IF-IT9505	Impulse IT95 Leg Extension - with 295lb weight stack	£3,122.01
IF-IT9506	Impulse IT95 Seated Leg Curl - with 200lb weight stack	£3,049.41
IF-IT9508	Impulse IT95 Abductor And Adductor - with 160lb weight stack	£2,683.23
IF-IT9510	Impulse IT95 Leg Press - with 295lb weight stack	£4,356.30
IF-IT9512	Impulse IT95 Shoulder Press - with 200lb weight stack	£2,869.47
IF-IT9514	Impulse IT95 Ab Machine - with 200lb weight stack	£2,648.50
IF-IT9515	Impulse IT95 (Reverse) Fly - with 160lb weight stack	£2,755.83
IF-IT9516	Impulse IT95 Rotary Calf - with 200lb weight stack	£2,699.01
IF-IT9517	Impulse IT95 Dip Press - with 295lb weight stack	£3,295.63
IF-IT9518	Impulse IT95 Torso Rotation - with 160lb weight stack	£2,632.72
IF-IT9519	Impulse IT95 Row - with 295lb weight stack	£3,080.97
IF-IT9520	Impulse IT95 Weight Assisted Chin/Dip Combo - with 200lb weight stack	£3,232.50
IF-IT9521	Impulse IT95 Prone Leg Curl - with 200lb weight stack	£2,733.73
IF-IT9522	Impulse IT95 Lat Pulldown With Middle Row - with 295lb weight stack	£3,027.31
IF-IT9524	Impulse IT95 Lateral Raise - with 200lb weight stack	£2,654.82
IF-IT9526	Impulse IT95 Glute - with 200lb weight stack	£2,702.17
IF-IT9532	Impulse IT95 Back Extension - with 200lb weight stack	£2,676.91

IMPULSE EXOFORM

The new impulse Fitness ExoForm Commercial Fixed Resistance range offers gym members an efficient and comfortable workout, at excellent value for you.

Designed by an American team of fitness experts, this range of strength training equipment was built to be durable, comfortable and safe, while taking up minimal space on the gym floor.



Cage: Same assembling height 150cm, metal top cover.

Timer and counter: Standard configuration on all models.

Tube: 3mm tube for all models. Main structure use R40x133x3 tube makes appearance more strong and tough.

Plastic part: Injection molding for better quality.

Handle: Patented ergonomic design with TPU material.

Incremental weight: 5lbs for smaller adjustment.

Weight stack: 19mm full steel plate. Weight Options

Easy to enter and exit the machine and able to adjust when in sitting position.



Pad: Seat and back pads are made by moulded PU foam. Use anti-slippery surface and add protect cover on the back. Various colours to choose from.

Suitable for people from 145cm to 195cm.

Standard metal part: Nickle plated os stainless steel for better appearance and quality.

Diverging motion structure allows the arm training simultaneously and alternately.

Belt and cable: Use fabric belt inside the cage and USA LOOS cable outside the cage to improve longevity.

Pulley: Lathed pulley with less tolerance.

Bearing: Reliable Taiwan brand.

Confirm with EN957. Passed 300,000 times fatigue test and 100kg stable test.

IMPULSE EXOFORM RANGE



FE9701 Chest Press

Dimensions (LxWxH): 1230 x 1570 x 1490mm



FE9702 Lat Pulldown

Dimensions (LxWxH): 1305 x 1230 x 2010mm



FE9703 Arm Curl

Dimensions (LxWxH): 1150 x 1567 x 1490mm



FE9705 Leg Extension

Dimensions (LxWxH): 1300 x 1240 x 1490mm



FE9708 Abductor/Adductor

Dimensions (LxWxH): 1736 x 1500 x 1490mm



FE9710 Leg Press

Dimensions (LxWxH): 1785 x 1350 x 1490mm



FE9712 Shoulder Press

Dimensions (LxWxH): 1765 x 1425 x 1490mm



FE9714 Abdominal

Dimensions (LxWxH): 1385 x 1210 x 1490mm

IMPULSE EXOFORM RANGE



FE9719 Row
Dimensions (LxWxH): 2000 x 1130 x 1490mm



FE9720 Weight Assisted Chin/Dip Combo
Dimensions (LxWxH): 1265 x 1186 x 1721mm



FE9721 Prone Leg Curl
Dimensions (LxWxH): 1705 x 1194 x 1490mm



FE9723 Arm Extension
Dimensions (LxWxH): 1150 x 1580 x 1490mm



FE9732 Back Extension
Dimensions (LxWxH): 1385 x 1225 x 1490mm



PRODUCT CODE	ITEM	PRICE
FE9701	Chest Press (295lb Weight Stack)	£4,196.35
FE9702	Lat Pulldown (200lb Weight Stack)	£3,692.67
FE9703	Arm Curl (160lb Weight Stack)	£3,836.16
FE9705	Leg Extension (295lb Weight Stack)	£3,991.37
FE9708	Abductor/Adductor (160lb Weight Stack)	£3,534.54
FE9710	Leg Press (295lb Weight Stack)	£5,319.62
FE9712	Shoulder Press (200lb Weight Stack)	£3,842.02
FE9714	Abdominal (200lb Weight Stack)	£3,209.49
FE9719	Row (295lb Weight Stack)	£4,082.15
FE9720	Weight Assisted Chin/Dip Combo	£4,181.71
FE9721	Prone Leg Curl (200lb Weight Stack)	£3,502.33
FE9723	Arm Extension (160lb Weight Stack)	£3,672.18
FE9732	Back Extension (200lb Weight Stack)	£3,710.24

IMPULSE STERLING

The SL range from Impulse redefines the concept of plate loaded strength training systems. Built to allow for isolateral movements, the machines movements work in sync with those of the human body. The smaller footprint of the products, accessible load points, ease of use and minimum maintenance helps this range appeal to all levels of gym user.

PRODUCT CODE	ITEM	PRICE
IF-SL7001	Impulse Sterling Chest Press	£1,619.00
IF-SL7002	Impulse Sterling Lateral Pulldown	£1,619.00
IF-SL7003	Impulse Sterling Shoulder Press	£1,619.00
IF-SL7004	Impulse Sterling Low Row	£1,649.00
IF-SL7005	Impulse Sterling Incline Chest Press	£1,649.00
IF-SL7006	Impulse Sterling Leg Press	£1,729.00
IF-SL7007	Impulse Sterling Row	£1,619.00
IF-SL7008	Impulse Sterling Rear Kick	£1,629.00
IF-SL7010	Impulse Sterling Plate Rack	£489.00
IF-SL7013	Impulse Sterling Glute Ham Bench	£819.00
IF-SL7017	Impulse Sterling Seated Calf Raise	£599.00
IF-SL7019	Impulse Sterling Incline Row	£879.00
IF-SL7020	Impulse Sterling 45 Leg Press	£3,129.00
IF-SL7021	Impulse Sterling Hack Squat	£2,579.00
IF-SL7023	Impulse Sterling Bicep Curl	£1,379.00
IF-SL7024	Impulse Sterling Tricep Dip	£1,629.00
IF-SL7025	Impulse Sterling Leg Extension	£1,629.00
IF-SL7026	Impulse Sterling Leg Curl	£1,659.00
IF-SL7027	Impulse Sterling Barbell Rack	£709.00
IF-SL7028	Impulse Sterling Olympic Flat Bench	£943.29
IF-SL7029	Impulse Sterling Olympic Incline Bench	£1,089.00
IF-SL7030	Impulse Sterling Olympic Decline Bench	£985.00
IF-SL7035	Impulse Sterling Flat Bench	£ 269.00



IF-SL7007 Impulse Sterling Row



IF-SL7002 Impulse Sterling Lateral Pulldown



IF-SL7004 Impulse Sterling Low Row



IF-SL7019 Impulse Sterling Incline Row



IF-SL7024 Impulse Sterling Tricep Dip



IF-SL7001 Impulse Chest Press



IF-SL7003 Impulse Sterling Shoulder Press



IF-SL7023 Impulse Sterling Bicep Curl

IMPULSE STERLING



IF-SL7026
Impulse Seated Leg Curl



IF-SL7020 Impulse Sterling 45 Leg Press



IF-SL7006
Impulse Sterling Leg Press



IF-SL7017
Impulse Seated Calf Raise



IF-SL7027
Impulse Sterling Barbell Rack



IF-SL7008
Impulse Sterling Rear Kick



IF-SL7013
Impulse Sterling Glute Ham Bench



IF-SL7025
Impulse Seated Leg Extension



IF-SL7021
Impulse Seated Hack Squat



IF-SL7010
Impulse Sterling Plate Rack



IF-SL7028
Impulse Sterling Olympic Flat Bench



IF-SL7029
Impulse Sterling Olympic Incline Bench



IF-SL7030
Impulse Sterling Olympic Decline Bench



IF-SL7035
Impulse Sterling Flat Bench

WEST COAST FITNESS

“

The gym's design has allowed us to offer our members the ultimate gym experience. We have almost all angles covered, being able to offer a large class studio, strength training room, main gym floor, spin studio and a dedicated rig room.

”

Simon Marshall
Owner
West Coast Fitness

IMPULSE PL (DUAL) RANGE

There are eight products in the Impulse PL range. Created for light commercial use in areas where space is limited they allow for some of the most popular exercises today. Again, design and innovation have been at the forefront of this range with eight dual function machines acting as 16 different workout stations offering the user total body training options.

PRODUCT CODE	ITEM	PRICE
IF-PL9002	Lat Pull Down and Seated Row	£1,789.00
IF-PL9010	Leg Press/Calf Raise (250lb)	£1,789.00
IF-PL9016	Inner/Outer Thigh (250lbs)	£1,789.00
IF-PL9019	Leg Extension/Leg Curl (250lbs)	£1,789.00
IF-PL9021	Multi Press (250lbs)	£1,789.00
IF-PL9022	Pec Dec/Rear Delt (170lbs)	£1,789.00
IF-PL9023	Bicep Curl/tricep Extension (170lbs)	£1,789.00
IF-PL9024	Abdominal/Low Back (250lbs)	£1,789.00



IF-PL9024
Impulse Dual Abdominal/Low Back (250lbs)



IF-PL9016
Impulse Dual Inner/Outer Thigh (250lbs)



IF-PL9023
Impulse Dual Bicep Curl/tricep Extension (170lbs)



IF-PL9021
Impulse Dual Multi Press (250lbs)



IF-PL9002
Impulse Dual Lat Pull Down and Seated Row



IF-PL9022
Impulse Dual Pec Dec/Rear Delt (170lbs)



IF-PL9019
Impulse Dual Leg Extension/Leg Curl (250lbs)



IF-PL9010
Leg Press/Calf Raise (250lb)

NAUTILUS INSPIRATION

Proudly made in the USA, the Nautilus Inspiration line delivers a series of must have updates to an outstanding strength circuit. Redesigned with beautiful, modern aesthetics and uniform towers, Nautilus Inspiration makes a powerful first impression.

Each machine captures the essence of natural human movement. Members will appreciate the many easy to use and easy to see features like the wrap around assisted seat adjustment, pre-stretch and range of motion controls designed to enhance each user's experience.



9-IPAM2 Nautilus Inspiration Abdominal



9-IPAA2 Nautilus Inspiration Adduction / Abduction



9-IPBE2 Nautilus Inspiration Back Extension



9-IPBC2 Nautilus Inspiration Biceps Curl



9-IPBA2 Nautilus Inspiration Bilateral Arms Curl



9-IPVP2 Nautilus Inspiration Chest Press



9-IPDA2 Nautilus Inspiration Dual Adj Pulley



9-IPPD2 Nautilus Inspiration Lat Pull Down



9-IPDR2 Nautilus Inspiration Deltoid Raise



9-IPGM2 Nautilus Inspiration Glute Press

NAUTILUS INSPIRATION

PRODUCT CODE	ITEM	PRICE
CHF-9-IPAA2	Nautilus Inspiration - Ab/Adduction	£4,788.93
CHF-9-IPAM2	Nautilus Inspiration - Abdominal	£4,608.21
CHF-9-IPBA2	Nautilus Inspiration - Bilateral Bicep Curl	£4,608.21
CHF-9-IPBC2	Nautilus Inspiration - Biceps Curl	£4,608.21
CHF-9-IPBE2	Nautilus Inspiration - Back Extension	£4,788.93
CHF-9-IPDR2	Nautilus Inspiration - Deltoid Raise	£4,608.21
CHF-9-IPGM2	Nautilus Inspiration - Glute Press	£4,788.93
CHF-9-IPLC2	Nautilus Inspiration - Leg Curl	£4,608.21
CHF-9-IPLE2	Nautilus Inspiration - Leg Extension	£4,608.21
CHF-9-IPLP2	Nautilus Inspiration - Leg Press	£6,144.29
CHF-9-IPPD2	Nautilus Inspiration - Lat Pulldown	£4,788.93
CHF-9-IPPF2	Nautilus Inspiration - Pec Fly/Rear Delt	£4,788.93
CHF-9-IPSP2	Nautilus Inspiration - Shoulder Press	£4,788.93
CHF-9-IPTD2	Nautilus Inspiration - Triceps Press	£4,608.21
CHF-9-IPTE2	Nautilus Inspiration - Tricep Extension	£4,608.21
CHF-9-IPVP2	Nautilus Inspiration - Chest Press	£4,788.93
CHF-9-IPVR2	Nautilus Inspiration - Row	£4,608.21



9-IPLP2 Nautilus Inspiration Leg Press



9-IPPF2 Nautilus Inspiration Pec Fly / Rear Delt



9-IPVP2 Nautilus Inspiration Vertical Row



9-IPLC2 Nautilus Inspiration Leg Curl



9-IPLE2 Nautilus Inspiration Leg Extension



9-IPSP2 Nautilus Inspiration Shoulder Press



9-IPBA2 Nautilus Inspiration Bilateral Arm Curl



9-IPTD2 Nautilus Inspiration Tricep Press

NAUTILUS HUMANSPORT

With a design inspired by the graceful, natural motions of the human body, HumanSport® offers a truly unique and human way of conditioning.

HumanSport® is so simple, so intuitive and so natural that it feels as if it were custom-built for each and every user. Six dual-function, cable based machines act as twelve workout stations by utilizing dual weight stacks to provide a wide range of total body training. Paired with a variety of included programming designed by our own Master Trainers, HumanSport® makes a powerful addition to any facility.



9-HSAC3 Nautilus Human Sport Arm/Crunch

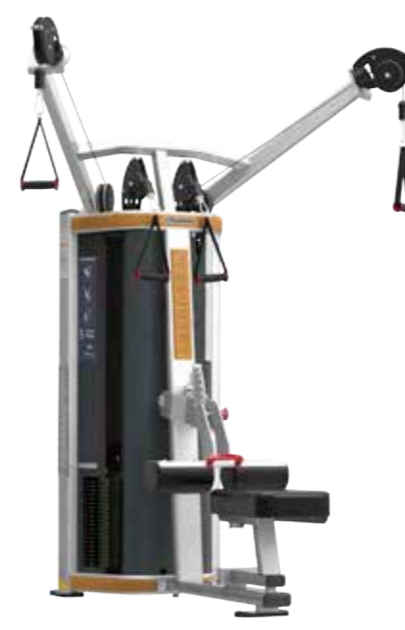

9-HSLP3 Nautilus Human Sport Lat/Pull



9-HSPL3 Nautilus Human Sport Pull/Lift

PRODUCT CODE	ITEM	PRICE
CHF-9-HSAC3	Nautilus Human Sport - Arm/Crunch	£6,598.90
CHF-9-HSLP3	Nautilus Human Sport - Lat/Pull	£6,598.90
CHF-9-HSPL3	Nautilus Human Sport - Pull/Lift	£6,598.90
CHF-9-HSSC3	Nautilus Human Sport - Shoulder/Chest	£6,598.90
CHF-9-HSTD3	Nautilus Human Sport - Total Delts	£6,598.90
CHF-9-HSTL3	Nautilus Human Sport - Total Legs	£6,598.90



9-HSSC3 Nautilus Human Sport Shoulder/Chest



9-HSTD3 Nautilus Human Sport Total Delts



9-HSTL3 Nautilus Human Sport Total Legs

WISHAW SPORTS CENTRE



We are delighted to be working in partnership with Origin Fitness to roll out our next generation of gym installations that will help us remain at the forefront of the health and fitness sector.



Nichola McLachlan
Health and Fitness Development Manager
North Lanarkshire Leisure

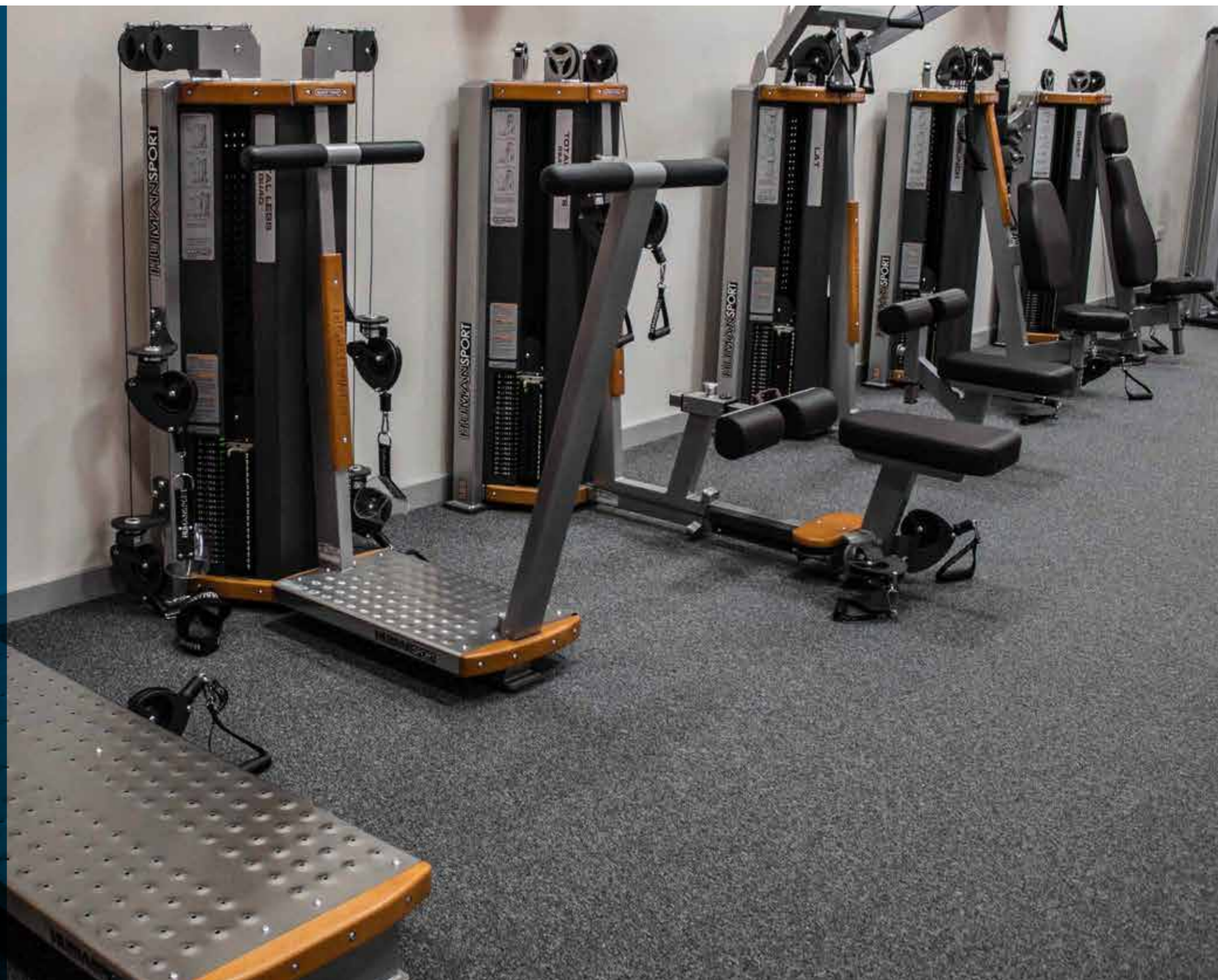

ORIGIN DUAL ADJUSTABLE PULLEY

The Origin Dual Adjustable Pulley boasts a full range of features including a 91kg weight stack on either side, allowing users to incrementally increase their weights as they progress. Included in this station is a range of cable attachments which, paired with the versatile positioning of the handles, enables varied and functional workouts for users.

Features

- Incremental weight stack allows users to easily increase their weights as their strength increases
- Selection of cable attachments included
- Smooth handle adjustment movement
- Incorporated cable attachment rack
- Pull up bars give users a more variable workout
- 91kg weight stack on each side
- Shrouds protect users from the moving weights & also feature workout posters to help users get the most out of their workout

Attachments Included:

- 1 x Long Bar
- 1 x Short Bar
- 1 x Tricep Rope
- 1 x Ankle Strap
- 2 x Single Handle



Selection of cable attachments included



Incorporated cable attachment rack



Workout posters included

DIMENSIONS	WEIGHT
1500mm (W) x 960mm (D) x 2150mm (H)	361.5kg

PRODUCT CODE	ITEM	PRICE
OF-OWM112-5	Origin Dual Adjustable Pulley	£3,023.90



ORIGIN CABLE CROSSOVER

The Origin Cable Crossover boasts a full range of features including a 91kg weight stack on either side, allowing users to incrementally increase their weights as they progress.

The cable crossover is a versatile piece of equipment and can be used to work every muscle in your body.

Features:

- Incremental weight stack allows users to easily increase their weights as their strength increases.
- Selection of cable attachments included.
- Smooth handle adjustment movement
- Cable attachment storage hooks
- Central pull up bar incorporated in unit
- 91kg weight stack on each side

Attachments Included:

- 1 x Curl Bar
- 1 x V-Handle
- 1 x Straight Bar
- 1 x Ankle Holder
- 2 x Single Handle

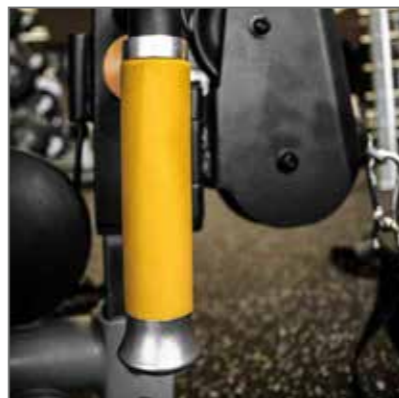

DIMENSIONS

4170mm (W) x 850mm (D) x 2440mm (H)

WEIGHT

399kg

PRODUCT CODE	ITEM	PRICE
OF-GRI-EWM111	Origin Cable Crossover	£3,848.90



Straight Bar



V-Handle



Multi Exercise Bar



Tricep Rope



Angled Pressdown Bar



Single Handle with Rubber Grip



36inch Lat Pull Down Bar

ORIGIN CABLE ATTACHMENTS

Origin Cable Attachments offer a huge amount of flexibility in how users can make use of cable strength machines like the Dual Adjustable Pulley and Cable Crossover. This selection of attachments will provide users all the tools needed to perform the cable exercises they choose to incorporate into their training.

PRODUCT CODE	ITEM	PRICE
NTS-TS4314	Straight Bar	£18.76
NTS-TS4341	Multi Exercise Bar	£28.86
NTS-TS4301	Tricep Rope	£18.76
NTS-TS4323	36inch Standard Lat Pull Down Bar	£36.08
NTS-TS4337	Angled Press Down Bar	£18.76
NTS-TS4307	Single Handle with Rubber Grip	£18.76
NTS-TS4311	V Handle	£18.76

ORIGIN CABLE ATTACHMENT RACK

The Origin Cable Attachment Rack is a stylish vertical rack with 19 holds for a variety of cable attachments.

PRODUCT CODE	ITEM	PRICE
NTS-VAR	Origin Cable Attachment Rack	£168.43



IMPULSE IT 4 STACK MULTI-STATION

The Impulse IT 4 Stack Multi-Station is the ideal piece of equipment to equip a comprehensive cables zone, however, it can also act as a full fixed resistance offering in gyms where space is limited or at a premium.

This 4 stack setup can be integrated with other cable stations to create 5 and 8 station configurations including the Impulse IT Adjustable Hi-Low Pulley by using the IT9327 Connector.

- Allows multiple users to train a variety of muscle groups at once
- Can be integrated using connectors to create five and eight station solutions.
- High quality steel construction provides stability and longevity
- Heavy 125kg weight stacks enable users of all abilities to train effectively

PRODUCT CODE	ITEM	PRICE
IF-IT9327	Impulse IT 4 Stack Multi-Station - 4 x 125kg Weight Stack	£5,774.04



IMPULSE IT7 RANGE BENCHES & RACKS

The Impulse IT7 Range of Benches and Racks is a tried and tested choice for anyone looking to equip the strength area of a gym. From storage racks for dumbbells and weight plates, to Smith machines, Olympic benches and other accessory strength pieces, the IT7 range is perfect for all types of facility.

- The IT7 line is one of the core commercial Impulse Fitness ranges
- User friendly design which makes training effective and comfortable
- Benches, racks and accessories have a simple, robust design which stands up to heavy use in gyms all around the world.



IF-IT7001 Smith Press



IF-IT7002 Seated Preacher Curl



IF-IT7003 Abdominal Training Bench



IF-IT7004 Stretch Trainer



IF-IT7005 Seated Calf Raise



IF-IT7006 Leg Press / Hack Squat

PRODUCT CODE	ITEM	PRICE
IF-IT7001	Impulse IT7 Smith Press	£1,979.00
IF-IT7002	Impulse IT7 Seated Preacher Curl	£409.00
IF-IT7003	Impulse IT7 Abdominal Training Bench	£679.00
IF-IT7004	Impulse IT7 Stretch Trainer	£409.00
IF-IT7005	Impulse IT7 Seated Calf Raise	£399.00
IF-IT7006	Impulse IT7 Leg Press / Hack Squat	£1,669.00
IF-IT7007	Impulse IT7 Multi Hyper Extension	£469.00
IF-IT7009	Impulse IT7 Flat Bench	£309.00
IF-IT7010	Impulse IT7 Vertical Knee Raise	£469.00
IF-IT7013	Impulse IT7 Multi-Adjustable Ab Bench	£384.04
IF-IT7014	Impulse IT7 Flat Bench Press	£679.00
IF-IT7015	Impulse IT7 Incline bench Press	£869.00
IF-IT7016	Impulse IT7 Decline bench Press	£809.00
IF-IT7017	Impulse IT7 Olympic Weight Plate Tree	£289.00
IF-IT7033	Impulse IT7 3D Smith Machine	£2,886.54

IMPULSE IT7 RANGE BENCHES & RACKS



IF-IT7007 Multi Hyperextension



IF-IT7009 Flat Bench



IF-IT7010 Vertical Knee Raise



IF-IT7013 Multi Adjustable Abdominal Bench



IF-IT7014 Flat Bench Press



IF-IT7015 Incline Bench Press



IF-IT7016 Decline Bench Press



IF-IT7017 Olympic Weight Plate Tree



IF-IT7033 3D Smith Machine

ORIGIN POWER RACK & HALF RACK

The Origin lifting racks are essential pieces of equipment for any gym, allowing for many heavy lifting workout exercises.

The racks both feature 15 secure racking positions at 10cm apart. These allow for full height adjustments of the spotting bar attachments and the durable hook attachments. Keeping weight plates organised is easy with the five outer weight plates storage bars.

The incorporated power band attachments allow users to easily increase resistance, or assistance, without the need for extra weight plates. The featured pull up bars allow for pronated (palms facing away), supinated (palms facing body), and close grip pull ups – a small, but essential feature of any good rack.

DIMENSIONS	WEIGHT
Power Rack: 2442mm (H) x 1755mm (W) x 1960mm (D)	216kg
Half Rack: 2442mm (H) x 1747mm (W) x 1960mm (D)	153kg

PRODUCT CODE	ITEM	PRICE
IF-OF-PR	Origin Power Rack	£1,731.54
IF-OF-HR	Origin Half Rack	£1,346.53



REVOLUTION FITNESS

“

Working with Origin has made the project run far more smoothly than we could have hoped. Should we ever undertake a project similar to this one, we would always adopt the help of Origin. Origin would come highly recommended by us.

David Crawford
Owner
Revolution Fitness

”





Adjustable seat



Transportation wheels



Transportation handle



Adjustable from -10° to 80°

ORIGIN MULTI ADJUSTABLE BENCH

The Origin Multi-Adjustable Bench is ideal for any commercial gym or for home use. It's -10° to +80° (in seven steps) enable incline, flat, and decline workouts allowing users to target specific muscle groups.

The bench comes with black, high-quality upholstery, a silver, matt metallic frame, and the moving parts are identified clearly by a bold red metallic finish with yellow handles. The backrest of the bench is adjustable from -10° to +80° enabling decline, flat and incline exercises which allow users to work specific muscle groups, and specific muscles within those groups.

The seat has 5 levels of adjustment angling upwards giving more support as the backrest inclines. The bench comes with two transportation wheels and also has a large handle making relocation of the bench easy and safe. The bench also has feet covers which protect the bench and the floor from any damage.

DIMENSIONS

1350 (L) x 670 (W) x 1350mm (H)

PRODUCT CODE	ITEM	PRICE
IF-OF-MAB-V2	Origin Multi Adjustable Bench	£528.41

ORIGIN PERFORMANCE RACKS

Our Origin Performance Racks are a complete solution for all strength and conditioning and free weight areas. Made from 3.6mm gauge powder coated tubular steel. All three racks come as standard with 10 point side weight storage, 1200mm wide multi grip (25mm) pull up bar and quick release single bar holders (adjustable every 120mm).





OF-PR-R002
Power Rack



Quick release bar holders adjustable every 120mm



Internal and external bar hook options

PRODUCT CODE	ITEM	PRICE
OF-PR-R001	Multi Rack	£2,910.60
OF-PR-R002	Power Rack	£3,201.66
OF-PR-R003	Half Rack	£2,328.48



OF-PR-R001
Multi Rack



OF-PR-R003
Half Rack

DUNDEE AND ANGUS COLLEGE

“

Origin Fitness has consistently provided Dundee and Angus College with excellent customer service and support. From initial design concepts, identifying the specific equipment to meet the different needs of our users, to the instillation and ongoing support. Working in partnership with Origin fitness, we now have gyms that reflect industry standards and our learners, staff, and general customers are benefiting from these exceptional facilities.

Stephen McGregor
Head of Sports and Fitness
Dundee and Angus College

”

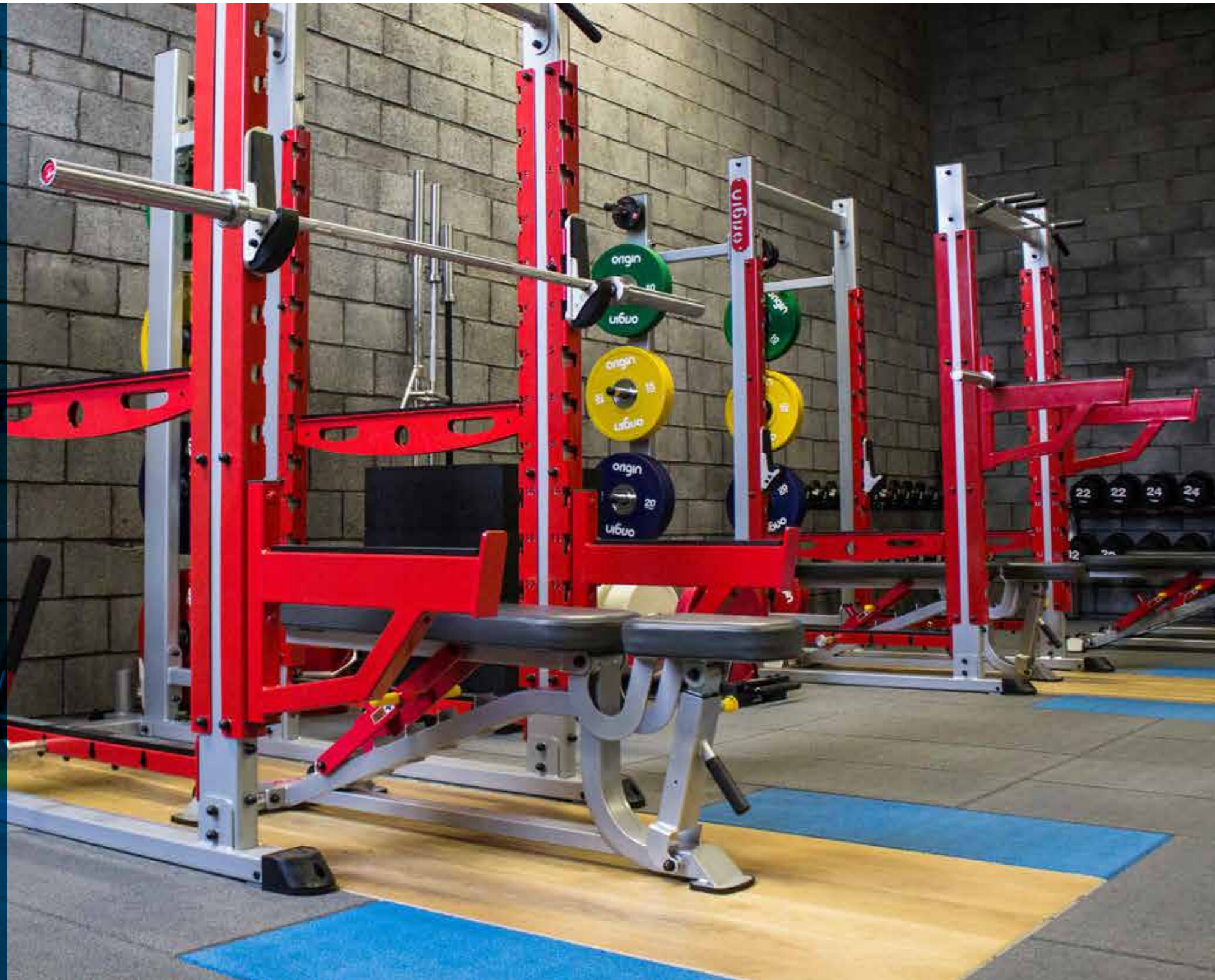

ORIGIN PLATFORMS & ACCESSORIES

Platforms can be integrated into all three of our performance rack options. All three racks can also accommodate various attachments which increase versatility and the training options available.



OF-PR-PF001
Integrated Half Rack Platform Compact



OF-FSPF-3X3
3m x 3m Free Standing Platform



OF-PR-A001
Bar Hooks (Left & Right)



OF-PR-A002
External Safety Spot Arms (Pair)

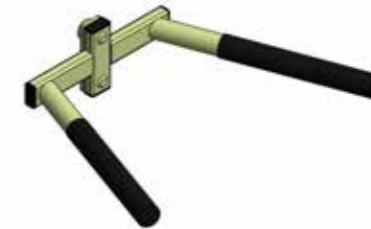

OF-PR-A003
Adjustable Dipping Frame



OF-PR-A004
Single Grapppler Attachment

PRODUCT CODE	ITEM	PRICE
OF-PR-A001	Bar Hooks (Left & Right)	£249.48
OF-PR-A002	External Safety Spot Arms (Pair)	£443.52
OF-PR-A003	Adjustable Dipping Frame	£334.72
OF-PR-A004	Single Grapppler Attachment	£138.60
OF-PR-A005	Olympic Bar Holder	£101.87
OF-PR-A006	Internal Safety Spot Arms	£443.52
OF-PR-A007	Resistance Band Pegs (pair)	£203.74
OF-PR-A008	Step Attachment	£308.33
OF-PR-PF001	Integrated Half Rack Platform Compact (1m impact zone)	£2,619.54
OF-PR-PF002	Integrated Half Rack Platform Deep (1.9m impact zone)	£2,924.12
OF-PR-PF003	Integrated Power / Multi Rack Platform	£2,924.12
OF-FSPF-3X2	3m x 2m Free Standing Platform	£2,459.46
OF-FSPF-3X3	3m x 3m Free Standing Platform	£2,677.29

FREE WEIGHTS

Free weights training is a critical provision for almost all types of gym. At Origin Fitness we've developed our ranges of dumbbells, barbells, Olympic bars, plates and accessories in order to meet the diverse free weights requirements of our many clients.

With strength sports like Olympic Weightlifting, Powerlifting and even CrossFit continuing to grow in popularity, demand for exciting free weights spaces equipped with high quality barbells and bumpers hasn't been as high as it is now.

[Dumbbells & Racks](#)

[Barbells & Racks](#)

[Weight Plates](#)

[Bars](#)

[Collars](#)

[Accessories & Storage](#)

ORIGIN RD2 RUBBER DUMBBELLS

A great addition to any gym, our RD2 Rubber Dumbbells are suitable for every type of user from beginner to expert. Sold in pairs they are highly durable and the modern design looks great in any gym environment. Due to the weights being single pieces of rubber they are less likely to be damaged and therefore, are able to withstand the busiest of studios and facilities.

Handle Length: 150mm

PRODUCT CODE	ITEM	PRICE	PRODUCT CODE	ITEM	PRICE
NTS-RD2-01	1kg Pair	£7.90	NTS-RD2-27-5	27.5kg Pair	£255.74
NTS-RD2-02	2kg Pair	£18.37	NTS-RD2-30	30kg Pair	£283.42
NTS-RD2-02-5	2.5kg Pair	£22.91	NTS-RD2-32-5	32.5kg Pair	£311.66
NTS-RD2-03	3kg Pair	£28.06	NTS-RD2-35	35kg Pair	£329.99
NTS-RD2-04	4kg Pair	£37.51	NTS-RD2-37-5	37.5kg Pair	£352.91
NTS-RD2-05	5kg Pair	£47.00	NTS-RD2-40	40kg Pair	£377.99
NTS-RD2-06	6kg Pair	£56.41	NTS-RD2-42-5	42.5kg Pair	£407.91
NTS-RD2-07	7kg Pair	£65.87	NTS-RD2-45	45kg Pair	£426.24
NTS-RD2-07-5	7.5kg Pair	£69.66	NTS-RD2-47-5	47.5kg Pair	£444.58
NTS-RD2-08	8kg Pair	£75.32	NTS-RD2-50	50kg Pair	£472.55
NTS-RD2-09	9kg Pair	£84.77	NTS-RD2-52-5	52.5kg Pair	£496.83
NTS-RD2-10	10kg Pair	£94.27	NTS-RD2-55	55kg Pair	£517.91
NTS-RD2-12-5	12.5kg Pair	£123.74	NTS-RD2-57-5	57.5kg Pair	£540.83
NTS-RD2-15	15kg Pair	£142.08	NTS-RD2-60	60kg Pair	£567.13
NTS-RD2-17-5	17.5kg Pair	£158.58	NTS-RD2-62-5	62.5kg Pair	£589.41
NTS-RD2-20	20kg Pair	£188.85	NTS-RD2-65	65kg Pair	£616.91
NTS-RD2-22-5	22.5kg Pair	£207.63	NTS-RD2-67-5	67.5kg Pair	£637.99
NTS-RD2-25	25kg Pair	£238.33	NTS-RD2-70	70kg Pair	£661.27



ORIGIN UD2 URETHANE DUMBBELLS

Our UD2 Urethane Dumbbells are made of extremely hard-wearing plastic polymer making them perfect for areas that see heavy usage. Sold in pairs, they have been designed with the end user in mind and are suitable for all, be it beginner or expert. Comfortable to hold and easy to maintain, they will look good in any gym.

Handle Length: 150mm

PRODUCT CODE	ITEM	PRICE
NTS-UD2-01	1kg Pair	£14.29
NTS-UD2-02	2kg Pair	£26.55
NTS-UD2-03	3kg Pair	£35.70
NTS-UD2-04	4kg Pair	£59.00
NTS-UD2-05	5kg Pair	£61.66
NTS-UD2-06	6kg Pair	£88.50
NTS-UD2-07	7kg Pair	£105.00
NTS-UD2-08	8kg Pair	£118.00
NTS-UD2-09	9kg Pair	£132.50
NTS-UD2-10	10kg Pair	£147.58
NTS-UD2-12	12kg Pair	£177.00
NTS-UD2-14	14kg Pair	£206.50
NTS-UD2-16	16kg Pair	£235.99
NTS-UD2-18	18kg Pair	£265.50
NTS-UD2-20	20kg Pair	£295.16
NTS-UD2-22	22kg Pair	£324.50
NTS-UD2-24	24kg Pair	£354.00
NTS-UD2-26	26kg Pair	£383.49
NTS-UD2-28	28kg Pair	£413.00
NTS-UD2-30	30kg Pair	£442.74
NTS-UD2-32	32kg Pair	£472.00

PRODUCT CODE	ITEM	PRICE
NTS-UD2-34	34kg Pair	£501.50
NTS-UD2-36	36kg Pair	£530.99
NTS-UD2-38	38kg Pair	£560.49
NTS-UD2-40	40kg Pair	£590.33
NTS-UD2-42	42kg Pair	£619.50
NTS-UD2-44	44kg Pair	£649.00
NTS-UD2-46	46kg Pair	£679.00
NTS-UD2-48	48kg Pair	£707.99
NTS-UD2-50	50kg Pair	£743.17
NTS-UD2-52	52kg Pair	£775.50
NTS-UD2-54	54kg Pair	£808.50
NTS-UD2-56	56kg Pair	£841.50
NTS-UD2-58	58kg Pair	£874.50
NTS-UD2-60	60kg Pair	£890.60
NTS-UD2-62	62kg Pair	£933.90
NTS-UD2-64	64kg Pair	£955.90
NTS-UD2-66	66kg Pair	£988.90
NTS-UD2-68	68kg Pair	£1,021.90
NTS-UD2-70	70kg Pair	£1,038.35



ORIGIN RD2 RUBBER DUMBBELL SETS

PRODUCT CODE	ITEM	PRICE
NTS-RD2-SET-1-10	1-10kg Set	£608.05
NTS-RD2-SET-1-10-VR	1-10kg Set Including Vertical Rack	£740.96
NTS-RD2-SET-2-5-25	2.5-25kg Set	£1,293.04
NTS-RD2-SET-2-5-25-HR	2.5-25kg Set with Horizontal Rack	£1,627.62
NTS-RD2-SET-2-5-30HR	2.5-30kg Set with Horizontal Rack	£2,169.41
NTS-RD2-SET-2-5-50	2.5-50kg Set	£4,956.03
NTS-RD2-SET-2-5-50HR	2.5-50kg Set with 2 Horizontal Racks	£5,625.18
NTS-RD2-SET-27.5-30	27.5-30kg Set	£490.14
NTS-RD2-SET-32.5-40	32.5-40kg Set	£1,372.56
NTS-RD2-SET-42.5-50	42.5-50kg Set	£1,751.28
NTS-RD2-SET-52.5-60	52.5-60kg Set	£2,122.69
NTS-RD2-SET-62.5-70	62.5-70kg Set	£2,505.58

ORIGIN UD2 URETHANE DUMBBELL SETS

PRODUCT CODE	ITEM	PRICE
NTS-UD2-SET-1-10	1-10kg Set	£788.76
NTS-UD2-SET-1-10-VR	1-10kg Set with Vertical Rack	£837.88
NTS-UD2-SET-2-20	2-20kg Set	£1,619.78
NTS-UD2-SET-2-20-HR	2-20kg Set with Horizontal Rack	£1,954.36
NTS-UD2-SET-2-30	2-30kg Set	£3,537.51
NTS-UD2-SET-2-30-HR	2-30kg Set with Horizontal Rack	£3,895.00
NTS-UD2-SET-2-40	2-40kg Set	£6,192.82
NTS-UD2-SET-2-40-2HR	2-40kg Set with 2 Horizontal Racks	£6,861.98
NTS-UD2-SET-2-50	2-50kg Set	£9,590.98
NTS-UD2-SET-2-50-2HR	2-50kg Set with 2 Horizontal Racks	£10,283.04



“

I had a very clear vision of what I wanted to achieve, and Matt worked with me to make this vision a reality. Origin Fitness provided all the equipment at a very competitive price, and I am very pleased with the work they have done. I would definitely recommend them to anyone looking to set up a new facility.

”

James Rivers
Owner
Gymbo's Health and Fitness



ORIGIN HEX RUBBER DUMBBELLS

The Origin Hex Rubber Dumbbells are sold as pairs and are made from solid steel handles with rubber covered ends. The hexagonal shape of the dumbbell eliminates rolling which in turn improves functionality and safety. The rubber coated ends helps to protect flooring, the dumbbell itself and any machines or storage racks.

PRODUCT CODE	ITEM	PRICE
NTS-TSD28-1	2 x 1kg	£5.36
NTS-TSD28-2	2 x 2kg	£10.72
NTS-TSD28-2-5	2 x 2.5kg	£13.40
NTS-TSD28-3	2 x 3kg	£16.08
NTS-TSD28-4	2 x 4kg	£21.44
NTS-TSD28-5	2 x 5kg	£26.80
NTS-TSD28-6	2 x 6kg	£32.16
NTS-TSD28-7	2 x 7kg	£37.51
NTS-TSD28-7-5	2 x 7.5kg	£40.19
NTS-TSD28-8	2 x 8kg	£42.87
NTS-TSD28-9	2 x 9kg	£48.23
NTS-TSD28-10	2 x 10kg	£53.59
NTS-TSD28-12-5	2 x 12.5kg	£66.99
NTS-TSD28-15	2 x 15kg	£80.39
NTS-TSD28-17-5	2 x 17.5kg	£93.79
NTS-TSD28-20	2 x 20kg	£107.18
NTS-TSD28-22-5	2 x 22.5kg	£120.58
NTS-TSD28-25	2 x 25kg	£133.98
NTS-TSD28-27-5	2 x 27.5kg	£147.38
NTS-TSD28-30	2 x 30kg	£160.78



ORIGIN HEX RUBBER DUMBBELL SETS & RACKS



PRODUCT CODE	ITEM	PRICE
NTS-HEX-SET-1-10VR	1-10kg Hex Dumbbell Set with Rack	£434.31
NTS-TS5020	10 Pair Vertical Dumbbell Rack (Silver)	£139.56
NTSHDBR-12	Origin Hex Dumbbell Rack (12 pair)	£332.50

ORIGIN 5 PAIR 2 TIER DUMBBELL RACK

This Origin 5 Pair 2 Tier Dumbbell Rack will keep your free weight area organised and clean.

- Keeps free weight area well-organised and clean
- Durable - with built in support to hold every weight
- Easily accessible - due to evenly distributed sections for the weights



DIMENSIONS

1355mm (W) x 700mm (D) x 900mm (H)

PRODUCT CODE	ITEM	PRICE
NTS-DBR-05	5 Pair 2 Tier Horizontal Dumbbell Rack	£139.56

ORIGIN 10 PAIR 2 TIER DUMBBELL RACK

This Origin 10 Pair 2 Tier Dumbbell Rack will keep your free weight area organised and clean

- Durable 50 x 50mm tubular steel frame.
- Rubber feet to protect floor
- Durable plastic saddles to hold dumbbells in place
- Will keep your free weight area organised and clean
- Dumbbells not included



DIMENSIONS

2940mm (L) x 700mm (D) x 900mm (H)

PRODUCT CODE	ITEM	PRICE
NTS-TS5033	10 Pair Dumbbell Rack 2 Tier (Silver)	£351.30

ORIGIN 12 PAIR 2 TIER DUMBBELL RACK

This Origin 12 Pair 2 Tier Dumbbell Rack will keep your free weight area organised and clean.

- Keeps free weight area well-organised and clean
- Durable - with built in support to hold every weight
- Easily accessible - due to evenly distributed sections for the weights



DIMENSIONS

2940mm (L) x 700mm (D) x 900mm (H)

PRODUCT CODE	ITEM	PRICE
NTS-TS5033	12 Pair Dumbbell Rack 2 Tier (Silver)	£354.08

ORIGIN RB2 RUBBER BARBELLS

The RB2 Rubber Barbells are part of our new generation of free weights products, designed with increased durability and improved design in mind. The single piece barbell end reduces risk of damage, and increases the longevity of the product. The simple, modern design will fit into any gym environment.

PRODUCT CODE	ITEM	PRICE
NTS-RB2-10	10kg	£46.56
NTS-RB2-15	15kg	£70.21
NTS-RB2-20	20kg	£93.86
NTS-RB2-25	25kg	£117.51
NTS-RB2-30	30kg	£141.16
NTS-RB2-35	35kg	£164.81
NTS-RB2-40	40kg	£188.46
NTS-RB2-45	45kg	£212.11



ORIGIN UB2 URETHANE BARBELLS

The Origin UB2 Urethane Barbells are part of our new generation of free weights products, designed with increased durability and improved design in mind. PU (poly-urethane) is a hard wearing plastic polymer which is resistant to scratches, marks, dents and discolouring. The single piece barbell end reduces risk of damage, and increases the longevity of the product. Their simple design will make them look great in any gym.

PRODUCT CODE	ITEM	PRICE
NTS-UB2-10	Origin UB2 Urethane Barbell 10kg	£61.18
NTS-UB2-15	Origin UB2 Urethane Barbell 15kg	£92.11
NTS-UB2-20	Origin UB2 Urethane Barbell 20kg	£123.06
NTS-UB2-25	Origin UB2 Urethane Barbell 25kg	£153.99
NTS-UB2-30	Origin UB2 Urethane Barbell 30kg	£184.93
NTS-UB2-35	Origin UB2 Urethane Barbell 35kg	£215.86
NTS-UB2-40	Origin UB2 Urethane Barbell 40kg	£246.81
NTS-UB2-45	Origin UB2 Urethane Barbell 45kg	£277.74



ORIGIN BARBELL SETS AND RACK

The Origin Rubber and Urethane Barbells sets consist of 10 barbells and the Origin Barbell Rack:

2 x 10kg	1 x 35kg
2 x 15kg	1 x 40kg
1 x 20kg	1 x 45kg
1 x 25kg	1 x Barbell Rack
1 x 30kg	

PRODUCT CODE	ITEM	PRICE
NTS-RB2-SET-10-45-R	Rubber Barbell Set with Rack	£1,486.06
NTS-UB2-SET-10-45-R	Urethane Barbell Set with Rack	£1,675.96
NTS-TS5046	Origin Barbell Rack	£351.30



ORIGIN RUBBER OLYMPIC WEIGHT PLATES

The Origin Rubber Olympic Weight Plates are coated in rubber in order to protect other machines, pieces of equipment and flooring. The three handle design allows users to easily place and replace plates, while also allowing for dynamic workouts out with the traditional barbell exercises.

The Origin Rubber Olympic Weight Plates are available in the following sizes:

PRODUCT CODE	ITEM	PRICE
NTS-TS4110-1	1.25kg	£3.65
NTS-TS4110-2	2.5kg	£7.50
NTS-TS4110-3	5kg	£14.91
NTS-TS4110-4	10kg	£29.83
NTS-TS4110-5	20kg	£60.15
NTS-TS4110-25	25kg	£72.52
NTS-OROWPSET-117-5	117.5kg Set (4 x 20kg, 2 x 10kg, 2 x 5kg, 2 x 2.5kg, 2 x 1.25kg)	£352.40



ORIGIN URETHANE OLYMPIC WEIGHT PLATES

The Origin Urethane Olympic Weight Plates are more durable than their rubber counterparts and still boast the same great features.

PRODUCT CODE	ITEM	PRICE
NTS-TS4110-6	1.25kg	£6.25
NTS-TS4110-7	2.5kg	£12.98
NTS-TS4110-8	5kg	£25.98
NTS-TS4110-9	10kg	£51.96
NTS-TS4110-10	20kg	£101.05
NTS-OUOWPSET-117-5	117.5kg Set (4 x 20kg, 2 x 10kg, 2 x 5kg, 2 x 2.5kg, 2 x 1.25kg)	£598.54

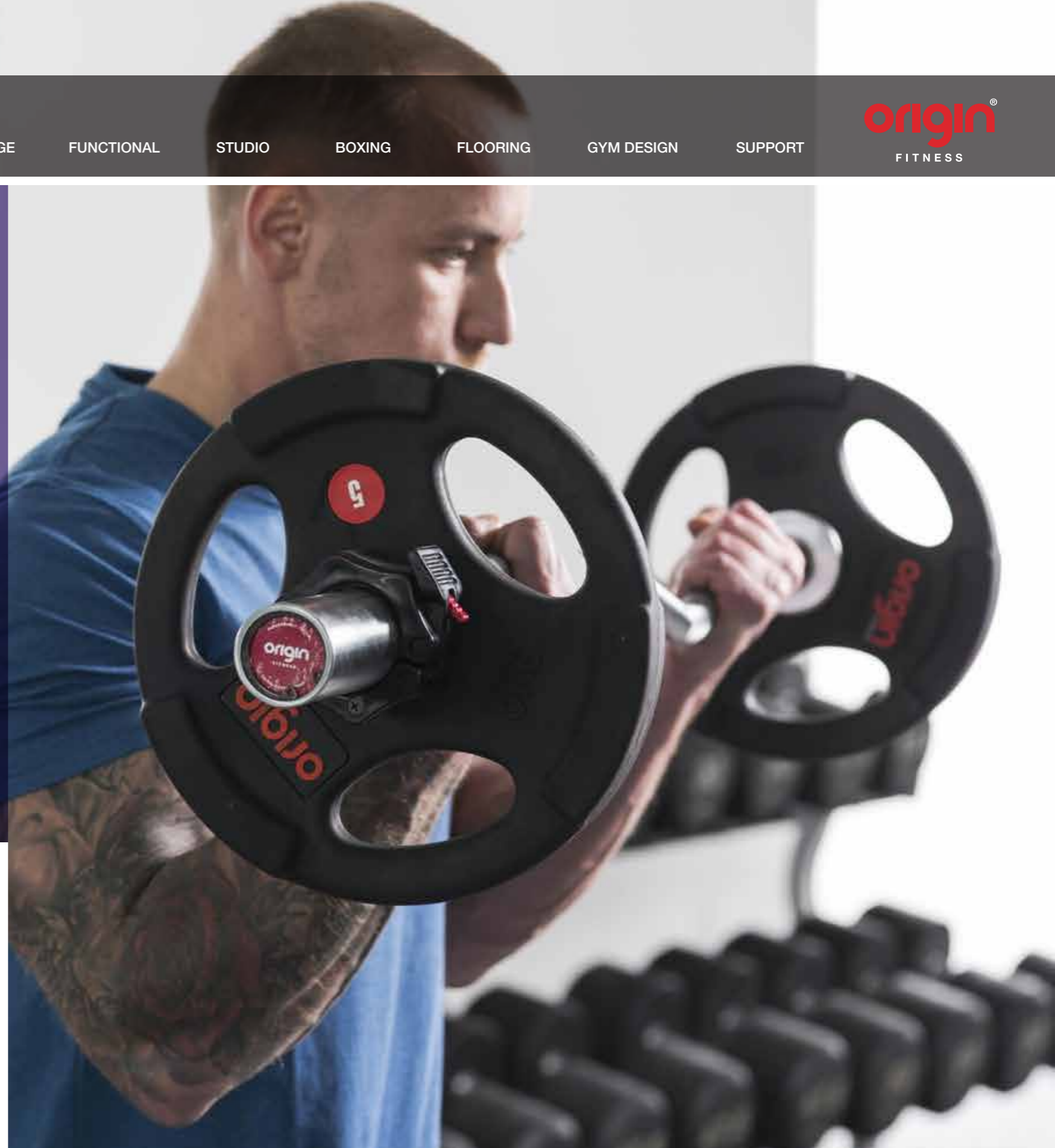

ORIGIN COLOURED URETHANE BUMPER PLATES

The Origin Coloured Urethane Bumper Plates offer increased durability and lifespan compared to rubber plates and also eliminates any rubber odours.

PRODUCT CODE	ITEM	PRICE
NTS-FW17U-5	5kg	£45.62
NTS-FW17U-10	10kg	£91.25
NTS-FW17U-15	15kg	£136.87
NTS-FW17U-20	20kg	£182.49
NTS-FW17U-25	25kg	£228.11
NTS-OCUOBPSET-110	110kg Set (4 x 20kg, 2 x 10kg, 2 x 5kg)	£1,003.70

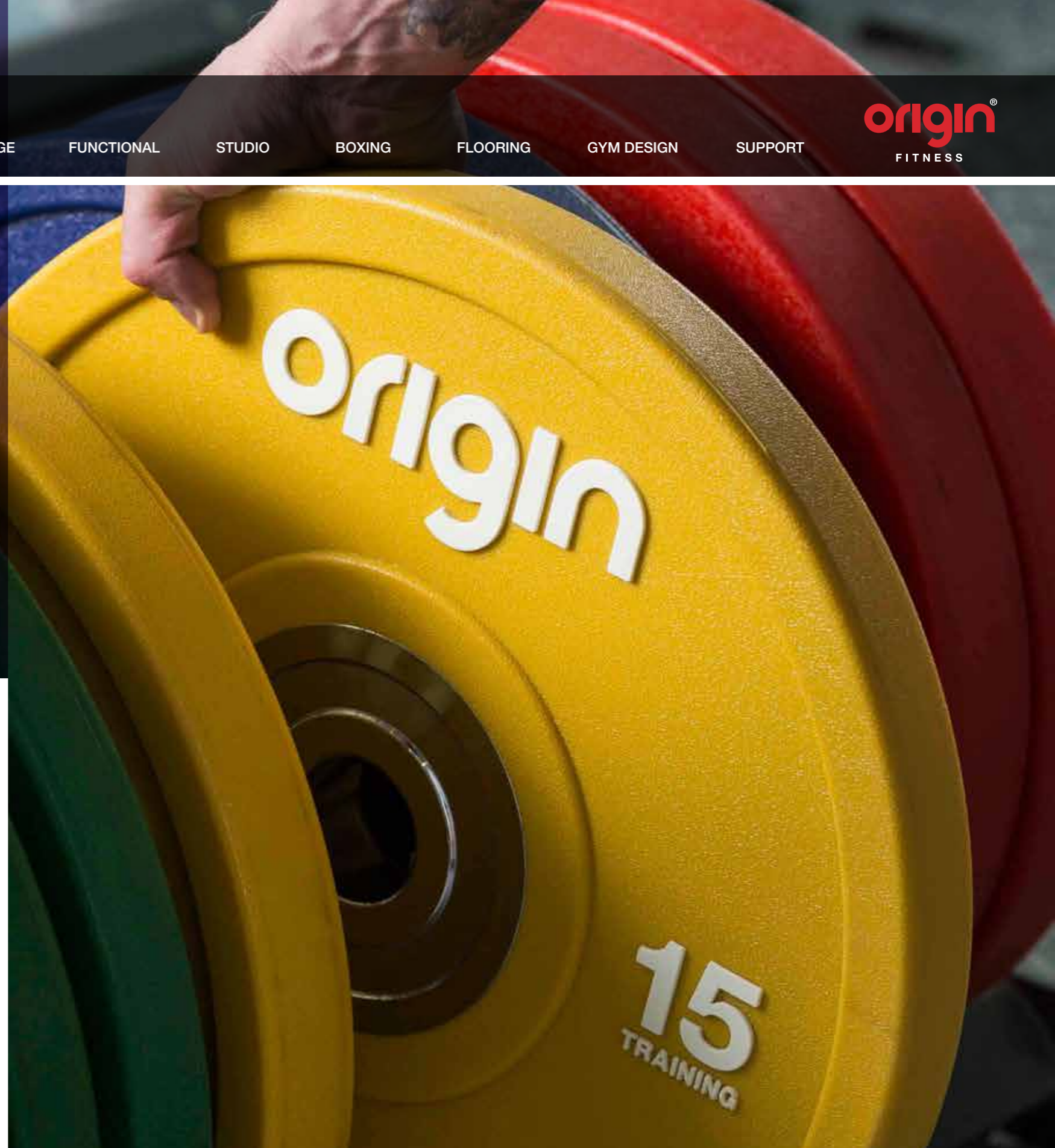

ORIGIN COLOURED RUBBER OLYMPIC BUMPER PLATES

The Origin Coloured Rubber Bumper Plates add life and colour to any free weights environment.

PRODUCT CODE	ITEM	PRICE
NTS-FW17R-5	5kg (Black)	£30.64
NTS-FW17R-10	10kg (Green)	£61.92
NTS-FW17R-15	15kg (Yellow)	£93.24
NTS-FW17R-20	20kg (Blue)	£124.49
NTS-FW17R-25	25kg (Red)	£155.41
NTS-OCROBPSET-110	110kg Set (4 x 20kg, 2 x 10kg, 2 x 5kg)	£683.07

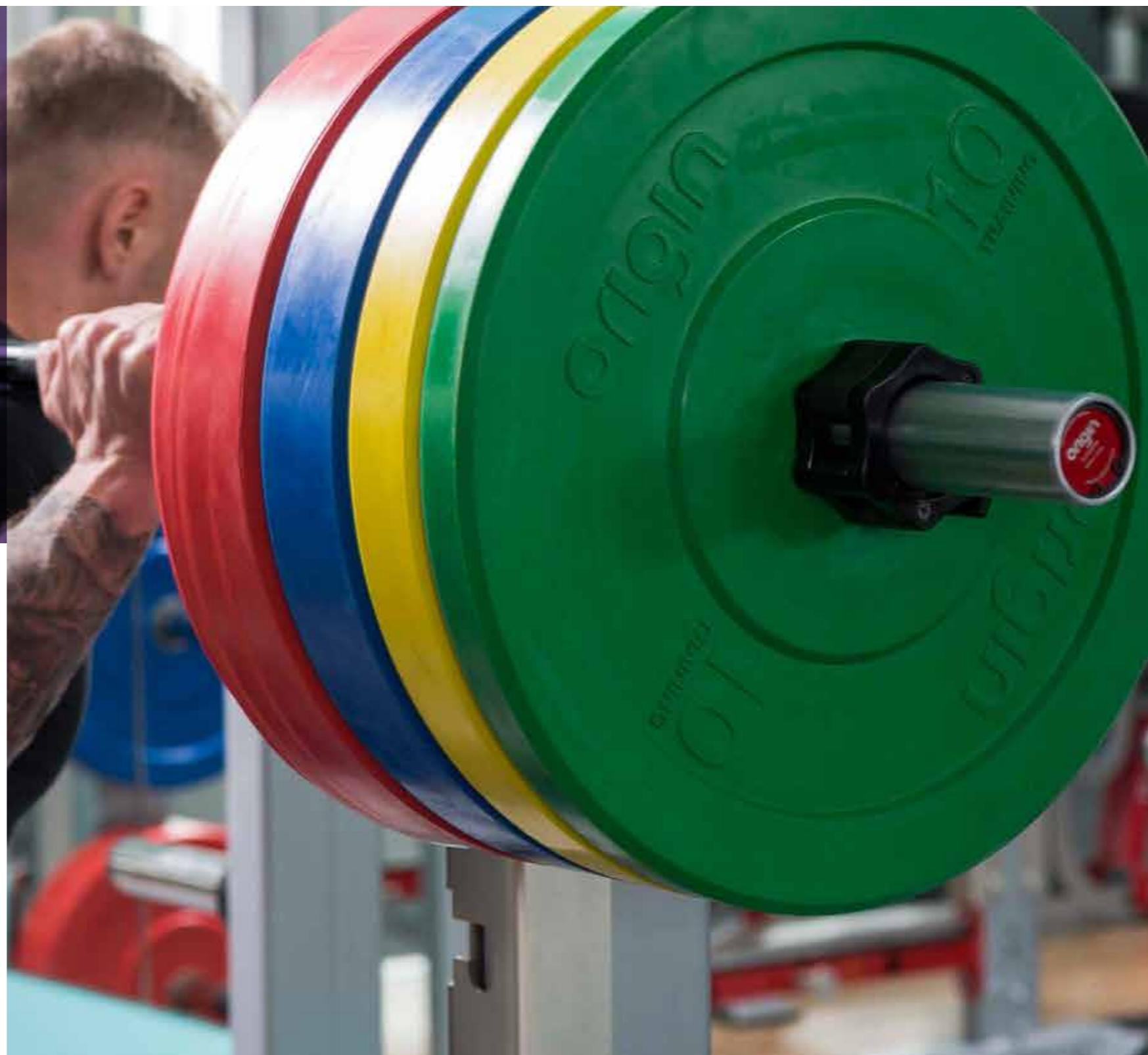

ORIGIN OLYMPIC BUMPER WEIGHTS

Origin Olympic Bumper Weight Plates allow users to perform dynamic lifts and Olympic movements without the fear of damaging equipment. The thicker rubber base will distribute force and reduce impact making them a robust, long lasting choice for weight lifting areas.

PRODUCT CODE	ITEM	PRICE
NTS-TS4125-5	5kg	£23.57
NTS-TS4125-10	10kg	£47.63
NTS-TS4125-15	15kg	£62.10
NTS-TS4125-20	20kg	£95.76
NTS-TS4125-25	25kg	£103.50





Zhangkong are specialists in competition and Olympic style weightlifting equipment. All of their products are approved by the International Weightlifting Federation (IWF), meaning they meet certain specifications required for use in Olympic competition. Zhangkong equipment was used in both the Beijing and Rio Olympic Games and is renowned for its precision and accuracy. The competition style equipment is approved by the International Weightlifting Federation (IWF) for use in Olympic lifting. The training equipment, whilst not suitable for competition, is also extremely accurate in weight and dimension. The discs are all colour coded as per IWF specification.

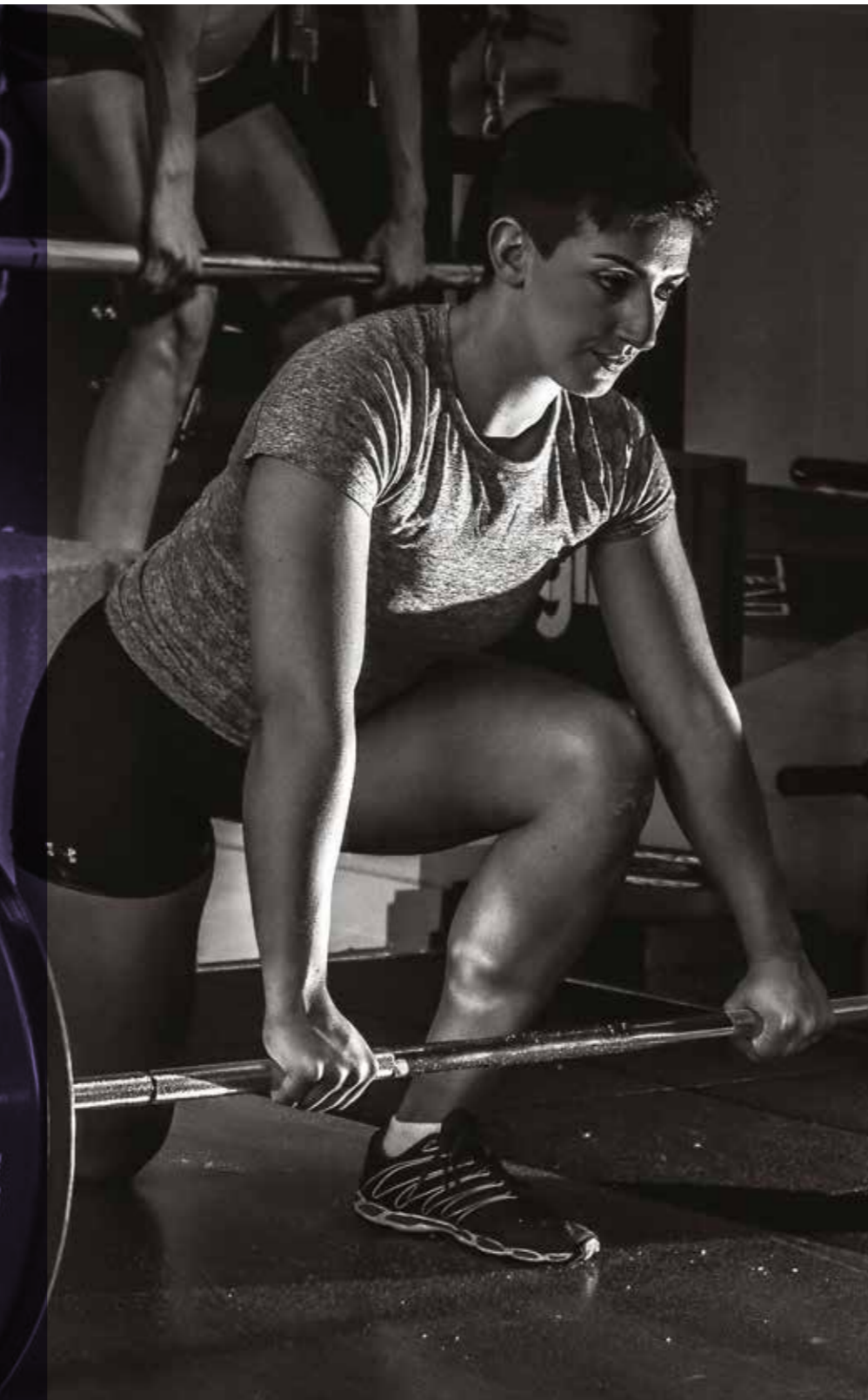

ZKC

IWF COLOURED COMPETITION PLATES

The Zhangkong IWF Coloured Weight Plates are approved by the International Weightlifting Federation. These plates are made of steel and have a rubber coating as per IWF specifications.

The diameter of the largest disc is 450mm with a tolerance of ± 1 mm. The bore diameter is 50mm. There is clear indication of weight on both sides of the plates as per IWF specifications. Weights are durable and are able to withstand impact associated with Olympic lifting.

PRODUCT CODE	ITEM	PRICE
ZK-ZKC-OBP-10	10kg	£150.15
ZK-ZKC-OBP-15	15kg	£184.80
ZK-ZKC-OBP-20	20kg	£231.00
ZK-ZKC-OBP-25	25kg	£271.43



ZKC

IWF STEEL INSERT COLOURED COMPETITION PLATES

The weight plates with steel inserts are also manufactured to the highest specification with IWF accreditation and are available in the following sizes:

PRODUCT CODE	ITEM	PRICE
ZK-ZKC-I-OBP-10	10kg	£259.88
ZK-ZKC-I-OBP-15	15kg	£297.41
ZK-ZKC-I-OBP-20	20kg	£332.06
ZK-ZKC-I-OBP-25	25kg	£360.94



ZKC

IWF BLACK / COLOUR TRAINING PLATES

The Zhangkong Training Plates are used for training purposes and, whilst they cannot be used in competitive events, they are still extremely precise in weight and dimension.

PRODUCT CODE	ITEM	PRICE
ZK-ZKX-OBP-T-10	10kg	£124.16
ZK-ZKX-OBP-T-15	15kg	£170.36
ZK-ZKX-OBP-T-20	20kg	£205.01
ZK-ZKX-OBP-T-25	25kg	£235.04



ZKC

IWF COLOURED COMPETITION INCREMENTAL PLATES

The Zhangkong Incremental Plates are IWF approved and can be used in competition environments.

The incremental plates allow users to add smaller amounts of weight to their barbells enabling easier progression.

Plates are available in the following increments:

PRODUCT CODE	ITEM	PRICE
ZK-ZKC-I-OBP-0-5	0.5kg	£24.83
ZK-ZKC-I-OBP-1	1kg	£34.07
ZK-ZKC-I-OBP-1-5	1.5kg	£43.31
ZK-ZKC-I-OBP-2	2kg	£60.64
ZK-ZKC-I-OBP-2-5	2.5kg	£69.30
ZK-ZKC-I-OBP-5	5kg	£129.94



POWER DISCS



Power Discs are strong and durable Olympic discs / bumper plates, which were designed with training performance in mind, perfect for beginner lifters, those who coach lifting, personal trainers, sports clubs, schools, Crossfit clubs, gyms and home gyms.

Key Features

- Made in the UK
- 100% Plastic
- One-Piece Construction
- Power Discs are ideal for: beginners, youth athletes, trainers, rehabilitation exercise
- Weight Options: 2.5kg (red) and 5kg (white)

PRODUCT CODE	ITEM	PRICE
PDL-PowerRWL-Discs-2-5kg	2.5kg - Red	£94.60
PDL-PowerRWL-Discs-5kg	5kg - White	£123.20

ORIGIN TECHNIQUE PLATES



The Origin Technique Plates are an excellent choice for beginners and those looking to add small increments of weight to their lifts as they look to improve their Olympic Weightlifting movements. Made of durable recycled plastic they are also suitable for those returning from injury as they allow users to start lifting light weights to slowly add weight. Origin Technique Plates are available in 2.5kg and 5kg weight options.

Key Features

- 100% recycled plastic
- One-piece construction
- Suitable for beginners, youth athletes, trainers and rehabilitation work
- Weight options: 2.5kg and 5kg

PRODUCT CODE	ITEM	PRICE
NTS-OTP 5	Origin 5kg Technique Weight Plate	£40.41
NTS-OTP 2.5	Origin 2.5kg Technique Weight Plate	£33.68

ORIGIN 7FT ALUMINIUM OLYMPIC TECHNIQUE BAR



The Origin 7ft Aluminium Technique Bar is perfect for improving Olympic lifting technique without having to use a full weight bar. Paired with technique plates, users get the full Olympic lifting experience with a reduced weight.

The Origin 7ft Olympic Technique Bar comes in at 12kg.

PRODUCT CODE	ITEM	PRICE
NTS-TECBAR-7	Origin 7ft Aluminium Olympic Technique Bar	£142.08

ORIGIN JERK BOXES



Ideal for perfecting lifting technique. Jerk boxes or blocks are an ideal addition for any gym or athlete focussed on weight lifting. The boxes remove the need to clean the bar to obtain the rack position. The Origin Jerk Boxes can be split and recombined to offer various height options.

Key Uses

- Block Pulls
- Cleans & Snatches
- Short Range Dead Lifts
- Floor Bench Presses
- Step-ups and Box Jumps

PRODUCT CODE	ITEM	PRICE
OF-OJB-01	Origin Jerk Boxes	£1,593.89

ORIGIN MEN'S 20KG & WOMEN'S 15KG COMPETITION WEIGHT LIFTING BAR

The new Origin Competition Barbells are our best barbells ever. The Competition barbell boasts a weight tolerance of +/- 1g, making it exceptionally accurate, in line with IWF specifications.

- Tested to a Tensile strength of: 216,200 psi and a Yield strength of: 206,900 psi
- Needle bearing provides a higher load capacity whilst still maintaining spin over bushings
- 1,500lbs (680.3kg) max capacity - 1,200lbs (544.3kg) for 15kg bar
- Threaded sleeves for extra grip
- IWF style knurling

PRODUCT CODE	ITEM	PRICE
OF-WLB003	Origin 20kg Men's Competition Weightlifting Bar	£495.00
OF-WLB004	Origin 15kg Women's Competition Weightlifting Bar	£480.00

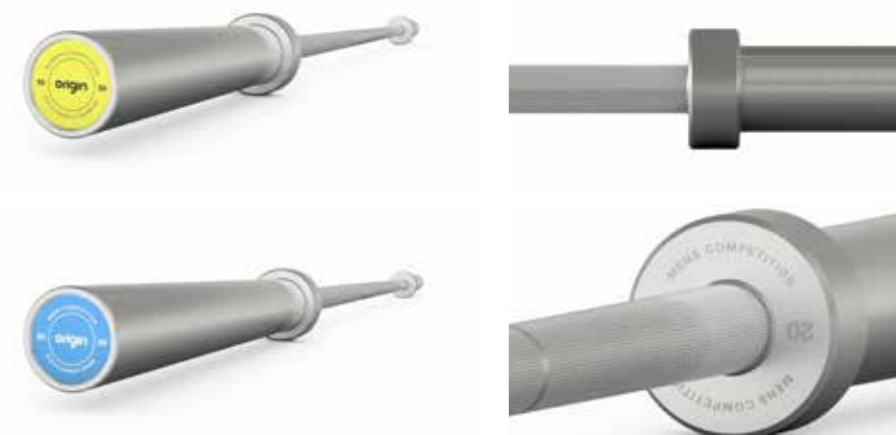
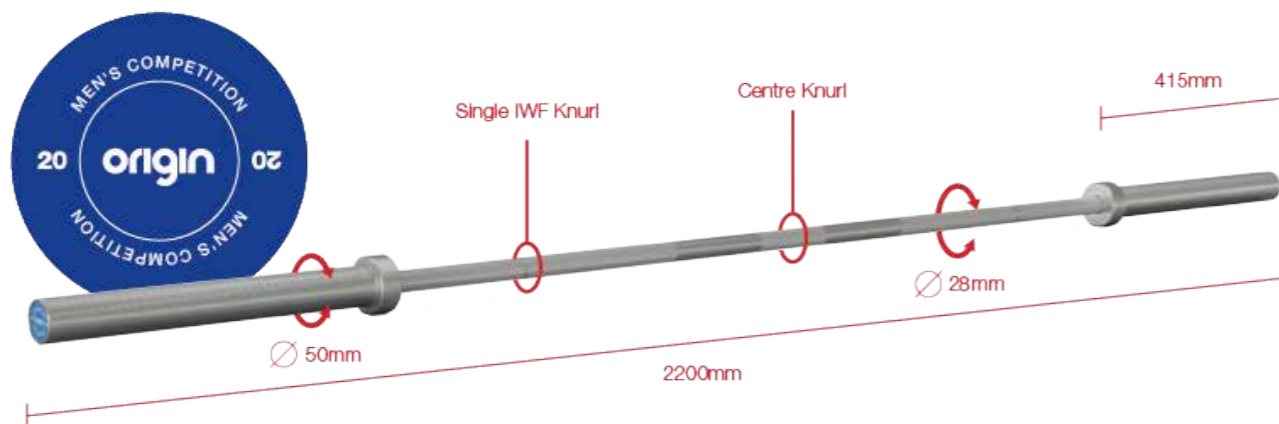

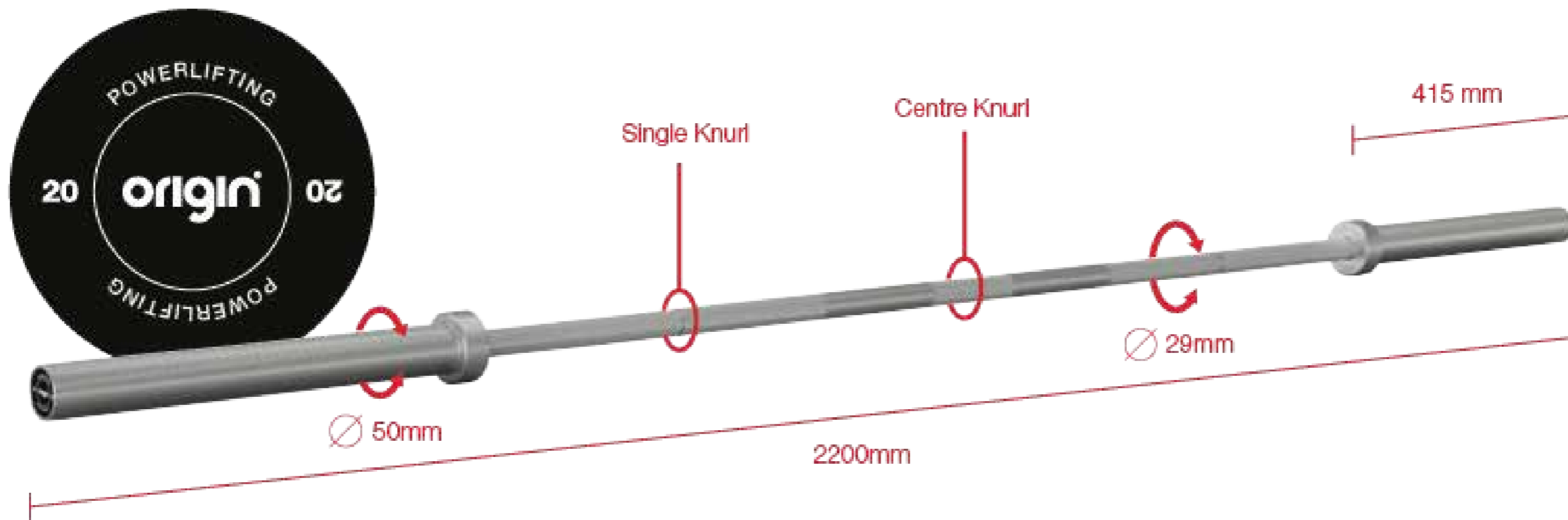

ORIGIN 20KG POWERLIFTING BAR

Our all new Origin Powerlifting Bar has been designed for the best and so meets IPF specifications. It's the ideal choice for serious lifters and training spaces where accuracy, performance and reliability and are paramount.

- Tested to a Tensile strength of: 216,200 psi and a Yield strength of: 206,900 psi
- Copper Bushing provides a high load capacity
- 1,500lbs (680.3kg) max capacity
- IPF Compliant



PRODUCT CODE	ITEM	PRICE
OF-WLB007	Origin 20kg Powerlifting Bar	£350.00

ORIGIN MEN'S 20KG & WOMEN'S 15KG CROSS TRAINING BAR

Our Origin Cross Training Bars are designed to be the perfect all-rounder for gyms that want a top-quality weightlifting bar. It features dual knurling with both IWF and IPF knurl markings to cater for a wider range of lifters.

- Tested to a Tensile strength of: 216,200 psi and a Yield strength of: 206,900 psi
- Copper Bushing provides a high load capacity
- 1,500lbs (680.3kg) max capacity - 1,200lbs (544.3kg) for 15kg bar
- Threaded sleeves for extra grip
- Dual Knurl (IWF + IPF Compliant)

PRODUCT CODE	ITEM	PRICE
OF-WLB009	Origin 20kg Mens Cross Training Bar	£295.00
OF-WLB010	Origin 15kg Women's Cross Training Bar	£285.00

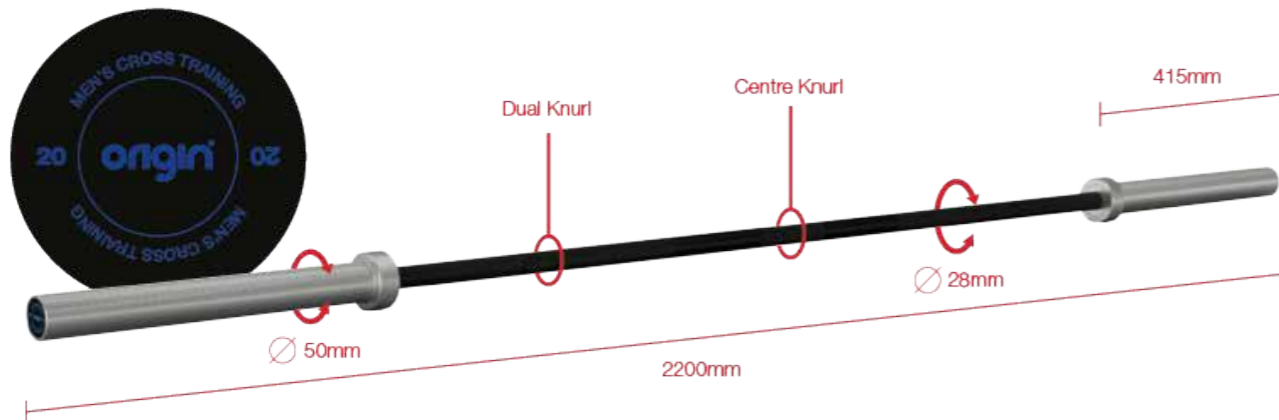

ORIGIN MEN'S 20KG & WOMEN'S 15KG BLACK ZINC BAR

The Origin High-Performance Bar is a high-grade Olympic bar featuring precision bearings for a smooth rotation. The steel bar is suitable for any Olympic weightlifting, powerlifting or weight training. Available in Brushed Steel or Black Zinc finish.

- High grade Olympic bar
- Precision bearings for a smooth rotation
- 190,000 psi steel
- Black Zinc finish for better feel and mild corrosion resistance
- Looks great in any facility

PRODUCT CODE	ITEM	PRICE
NTS-OWB-M-BK	Men's 20kg - Black Zinc	£240.62
NTS-OWB-W-BK	Woman's 15kg - Black Zinc	£192.49



ORIGIN MEN'S 20KG & WOMEN'S 15KG BRUSHED STEEL BAR

Every detail of our Origin Brushed Steel Bar is manufactured to the highest standard and has been tested to 190,000 psi. The bars brushed steel finish is far more durable than traditional chrome bars, and looks great in any facility.

- High grade Olympic bar
- Precision bearings for a smooth rotation
- Suitable for any Olympic weightlifting, powerlifting or weight training
- More durable than traditional chrome bars
- Looks great in any facility

PRODUCT CODE	ITEM	PRICE
NTS-OWB-M	Men's 20kg - Brushed Steel	£240.62
NTS-OWB-W	Woman's 15kg - Brushed Steel	£192.49



ORIGIN 5FT PERFORMANCE OLYMPIC BAR

This high grade Olympic bar, features a modern brushed steel finish which makes it more durable than regular chrome bars.

Bar thickness: 28mm
Sleeve thickness: 50mm

ORIGIN 6FT PERFORMANCE OLYMPIC BAR

This high grade Olympic bar, features a modern brushed steel finish which makes it more durable than regular chrome bars.

Bar thickness: 28mm
Sleeve thickness: 50mm



DIMENSIONS	WEIGHT
(L)152cm	13kg

DIMENSIONS	WEIGHT
(L)182cm	15kg

PRODUCT CODE	ITEM	PRICE
NTS-OWB-5	5ft Olympic Weight Bar - Brushed Steel	£139.56

PRODUCT CODE	ITEM	PRICE
NTS-OWB-6	6ft Olympic Weight Bar - Brushed Steel	£158.80

“

I have been using Origin Equipment in the performance centre that I work out of on a day to day basis for the past 12 months and I am very impressed with the build quality of their equipment.”

Marc Keys

Professional Strength and Conditioning Coach and Founder of Cast Iron Strength/Edinburgh Barbell

ORIGIN OLYMPIC CURL EZ BAR - BRUSHED STEEL

The Origin Olympic Curl EZ Bar opens up users to more dynamic exercises and a new range of motions that are not achievable with straight bars.

Bar thickness: 25mm
Sleeve thickness: 50mm

PRODUCT CODE	ITEM	PRICE
NTS-OWB-EZ	EZ Curl Olympic Weight Bar - Brushed Steel	£129.93



ORIGIN 10KG EZ CURL BAR

The Origin 10kg EZ Curl Bar is the ideal weightlifting bar for a wide range of accessory and bodybuilding exercises. The bar is accurately designed to weight exactly 10kg and is tested to a max load capacity of 181.4kg.

Bar thickness: 28mm
Sleeve thickness: 50mm

PRODUCT CODE	ITEM	PRICE
OF-WLB014	Origin 10kg EZ Curl Bar	£175.00



ORIGIN SUPER CURL BAR

The Origin Super Curl Bar allows for even more arm rotation and versatility.

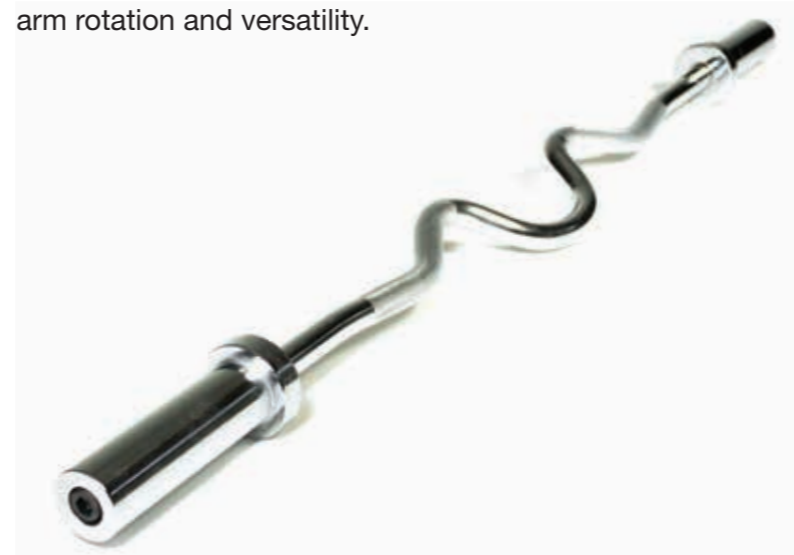

DIMENSIONS	WEIGHT
(L)125cm	8kg

PRODUCT CODE	ITEM	PRICE
NTS-TSSCB	Super Curl Weight Bar	£96.25

ORIGIN HEX BAR

The Origin Hex Bar gives users more stability when performing deadlifts and places hands in a more natural position.

6ft bar weighs 25kg
7ft bar weighs 30kg

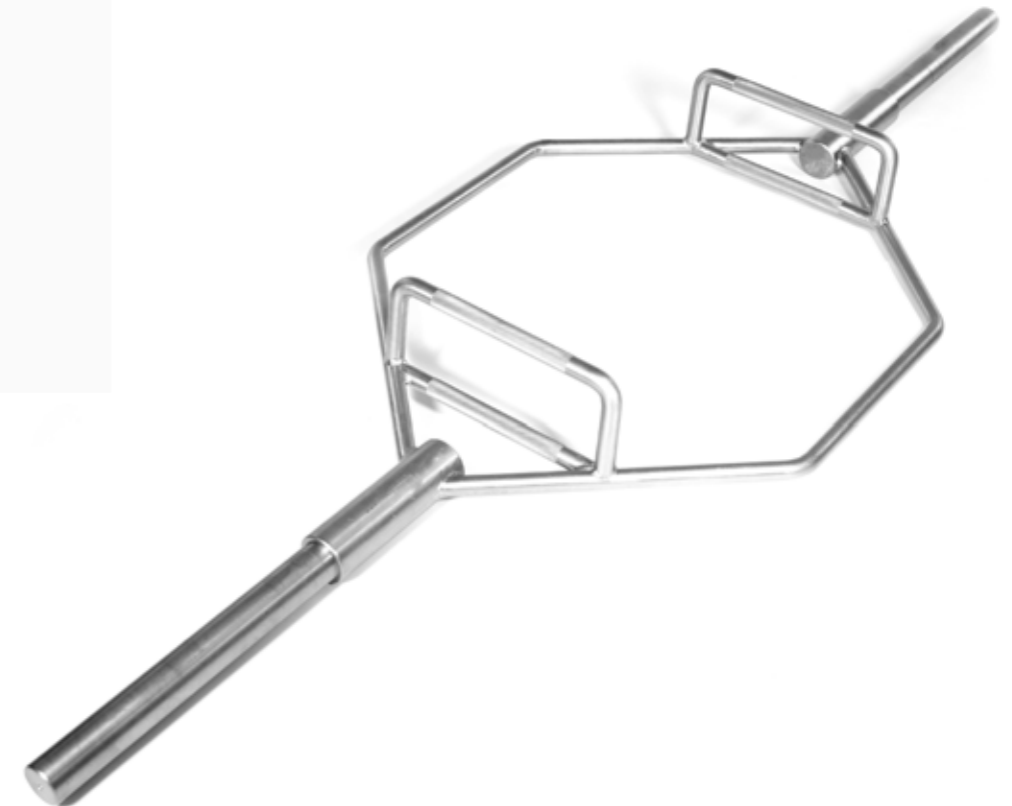

PRODUCT CODE	ITEM	PRICE
NTS-TSHB6	6ft Origin Hex Bar	£144.36
NTS-TSHB7	7ft Origin Hex Bar	£163.62

ZKC MEN'S TRAINING BAR

The Zhangkong Men's competition bar has a flexible feel and is ideal for explosive snatch and clean & jerk movements, with a sprung steel shaft tested to a force of 1500kg needle and bearings which give the bar effortless spin. It can withstand the impacts associated with Olympic lifts and is approved by the IWF.

PRODUCT CODE	ITEM	PRICE
ZK-ZKX-I-OB-M	Men's Training Bar	£860.48

ZKC WOMEN'S TRAINING BAR

The Zhangkong Women's competition bar has a flexible feel and is ideal for explosive snatch and clean & jerk movements, with a sprung steel shaft tested to a force of 1500kg and needle bearings which give the bar effortless spin. It can withstand the impacts associated with Olympic lifts and is approved by the IWF.

PRODUCT CODE	ITEM	PRICE
ZK-ZKX-II-OB-W	Women's Training Bar	£860.48

MEN'S COMPETITION BAR

The Zhangkong Men's competition bar has a flexible feel and is ideal for explosive snatch and clean & jerk movements, with a sprung steel shaft tested to a force of 1500kg needle and bearings which give the bar effortless spin. It can withstand the impacts associated with Olympic lifts and is approved by the IWF.

Weight 20kg, Max load 387kg



PRODUCT CODE	ITEM	PRICE
ZK-ZKC-I-OB-M	Men's Competition Bar	£987.53

WOMEN'S COMPETITION BAR

The Zhangkong Women's competition bar has a flexible feel and is ideal for explosive snatch and clean & jerk movements, with a sprung steel shaft tested to a force of 1500kg and needle bearings which give the bar effortless spin. It can withstand the impacts associated with Olympic lifts and is approved by the IWF.

Weight 15kg, Max load 258kg



PRODUCT CODE	ITEM	PRICE
ZK-ZKC-II-OB-W	Women's Competition Bar	£987.53

ORIGIN OLYMPIC SPRING COLLARS



The Origin Olympic Spring Collars can be firmly attached to all Olympic style bars.

PRODUCT CODE	ITEM	PRICE
NTS-SC	Origin Olympic Spring Collars	£7.50

ORIGIN CLAMP COLLARS



The Origin Clamp Collars can be used on all Olympic style bars. Made of durable plastic they are secure and easy to use.

PRODUCT CODE	ITEM	PRICE
NTS-OCC	Clamp Collars	£18.76

ZKC COMPEITION COLLARS



Zhangkong collars are 2.5kg and fasten securely to any Olympic bar. The competition collars are IWF approved and are suitable for competition use.

PRODUCT CODE	ITEM	PRICE
ZK-ZKC-I-OC	Zhangkong Competition collars	£340.73

ZKC TRAINING COLLARS



The training collars have a slightly higher margin for error than the competition collars however, they are still extremely accurate and can be used in any Olympic Lifting training environment.

PRODUCT CODE	ITEM	PRICE
ZK-ZKC-I-OC	Zhangkong Competition collars	£311.85

ORIGIN NECK PROTECTOR

The Origin Neck Protector is manufactured from a cushioning foam that easily wraps around a barbell - to protect your neck and back when lifting. Easily attachable, the Origin Neck Protector has a strip of Velcro at the back provides a quick and easy method of attaching to the bar.

- Protect your neck when lifting barbells
- Manufactured from a cushioning foam that provides comfort when lifting
- Simplistic design that suits both commercial and home gyms
- Easily attachable



PRODUCT CODE	ITEM	PRICE
NTS-NP-01	Origin Neck Protector	£18.89

ORIGIN LIFTING CHAINS

The Origin Lifting Chains allow users to incorporate strength curves into training regimes. Strength curves represent how much force can be produced at specific joint angles.

Training with lifting chains helps users to improve stability, strength and the ability to power through each stage of particular lifts.

- Available in 3 sizes: 20mm, 25mm, 30mm
- Fits on all Olympic size bars
- All 1800mm in length
- Aid a progressive lift
- Sold Individually



PRODUCT CODE	ITEM	PRICE
NTS-LC-20	Origin Lifting Chains 20mm	£152.24
NTS-LC-25	Origin Lifting Chains 25mm	£209.99
NTS-LC-30	Origin Lifting Chains 30mm	£299.89

ORIGIN DIPPING BELT

The Origin Fitness Dipping Belt is the perfect training tool for adding extra load to a whole range of bodyweight and gymnastic movements. From dips and pull-ups to hip belt squats, this accessory can add a new dimension to your training.

The Dipping belt also features a 16cm high padded back that protects the user, as well as offering superior comfort when in use.

- One size fits all
- Padded back for comfort and safety
- 16cm back support
- 2x steel D-shaped carabiners for easy adjustment
- Made from durable polyester with an EVA + foam core



PRODUCT CODE	ITEM	PRICE
NTS-ODB-01	Origin Dipping Belt	£37.79

ORIGIN WEIGHT LIFTING BELT

Made from strong durable leather with a padded internal lining, the Origin Weight Lifting Belt offers support and comfort for your most demanding lifts. With 12 belt notches, the belt can be adjusted to fit most athletes and offer additional strength and protection to the back, exactly when you need it most.

- Dual prong buckle for easy and secure fastening
- Provides back support during heavy lifts
- Adjustable between 35" and 46" with 12 notches
- Padded core for comfort



PRODUCT CODE	ITEM	PRICE
NTS-WLB-01	Origin Weight Lifting Belt	£14.99

“

At Origin Fitness we're always looking forward, trying to make sure we offer innovative solutions to our customers. The entire Origin team is fully committed to this and to delivering a level of service we believe is second to none.

Paul Bodger
Managing Director
Origin Fitness

”

ORIGIN TOASTER RACK

The Origin Toaster Rack is the ideal for solution for keeping free weights zones and weight lifting areas organised. The lifting handle and wheels allow easy storage and transportation around the gym. Keeping your gym safe and tidy has never been so simple.

- Keeps weight plate area safe and tidy
- Transportation wheels for easy manoeuvrability
- Handle to easily guide rack in different locations
- Will hold: 2x25kg 2x20kg 2x15kg 2x10kg 2x5kg Origin Olympic weight Plates - when the smaller slots will hold incremental plates.



PRODUCT CODE	ITEM	PRICE
NTS-OTR-01	Origin Toaster Rack	£99.99

ZKC BARBELL LIFTER

The Zhangkong Barbell Lifter makes assembling, moving and disassembling your barbells easy and safe.



PRODUCT CODE	ITEM	PRICE
ZK-ZKC-I-OBBL	Zhangkong Barbell lifter	£710.33

ORIGIN DROP-IN LANDMINE

The Origin Drop-In Landmine is an essential tool for any strength and mobility training programme. Due to its lightweight yet commercially durable design, it can be quickly put in to place and used with all standard Olympic weight plates. The two point rotation axis allows for dynamic full body movements, increasing ease of use and allowing for total body workouts.

- Will accommodate all Olympic size bars (50mm)
- Lightweight and portable
- Can be inserted into any Olympic size weight plate
- Rotates on two axis points enabling dynamic movement
- Sleek black powder coat finish

Bar and Plates not included



PRODUCT CODE	ITEM	PRICE
NTS-DILM	Origin Drop-In Landmine	£39.99

ORIGIN WEIGHT BAR HOLDER

Made of steel the Origin Weight Bar Holder can accommodate up to five Olympic size bars. The base also has two holes which allow the unit to be fixed to the floor. We recommend this to keep your weight bars safe and secure.

- Holds five Olympic weight bars
- Sleek steel finish
- Ideal space saving solution
- Dimensions: 265mm x 265mm
- Height: 210mm

Due to their uneven weight distribution, Hex bars or other speciality bars should not be stored in the Origin Weight Bar Holder.



PRODUCT CODE	ITEM	PRICE
NTS-WBH	Origin Weight Bar Holder	£71.28

ORIGIN WALL MOUNTED WEIGHT BAR RACK

The Origin Wall Mounted Weight Bar Rack is an ideal storage solution for all gyms. By storing bars horizontally, the bearings and fixings within the sleeves of the bars are saved from premature wear, while simultaneously reducing clutter on the gym floor.

The Origin Wall Mounted Weight Bar Racks can accommodate bars of all weights and sizes.

- Will hold up to three weight bars
- Keeps loose bars off the gym floor
- Storing weight bars horizontally prevents strain on sleeves and bearings
- Comes with wall fixings
- Stylish powder coated finish



PRODUCT CODE	ITEM	PRICE
NTS-BBWR-01	Origin Wall Mounted Weight Bar Rack	£100.79

RIGS & STORAGE

Origin Fitness Functional Training Rigs open up a whole range of opportunities for coaches to create unique and exciting workouts. While allowing trainers to be creative, they also give users the tools to challenge themselves with simple functional, callisthenics and bodyweight movements. This makes them attractive to CrossFit affiliates and gyms with a focus on functional training and conditioning circuits.

[Origin Functional Training Rigs](#)

[Origin Performance Rigs](#)

[Modular Storage Rigs](#)

FUNCTIONAL RIGS

The Origin Functional Rig combines the best features of a functional rig with some gym floor favourites to create a modular system that maximises the space available. Build in features like a half rack, rebounder, boxing station and even dual adjustable pulley to create a rig that can change the way your gym floor works for the better.



ORIGIN X-SHAPE FUNCTIONAL RIG

IF-OF-X

DIMENSIONS	STATIONS	USERS
7489mm x 3139mm x 2490mm	4	12-14

The X-Shape rig configuration is the largest configuration. It incorporates four of the five workout stations, two ladders joined by a single connector, and (also) any attachments that might be required.

There are five possible combinations without repeating any stations.

This rig offers the greatest total of available workout space, meaning this configuration allows for the most users.

CODE	REQUIRED CONNECTORS
IF-OF-IZ7006	Origin Functional Rig - Connector
IF-OF-IZ7007	Origin Functional Rig - Stair2 Attachment
IF-OF-IZ7007	Origin Functional Rig - Stair2 Attachment



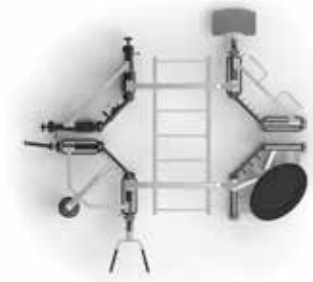

H-SHAPE RIG

IF-OF-H

DIMENSIONS	STATIONS	USERS
4137mm x 2880mm x 2490mm	4	9-11

The H-Shape functional rig configuration consists of four workout connectors, joined by two single connectors and a ladder.

The key feature of the H-Shape functional rig is its ability to accommodate multiple users on a wide variety of stations, while not requiring the space necessary for an X shape rig. Four workout stations and a functional area in between - all confined within a small 4.2m x 2.9m area.

CODE	REQUIRED CONNECTORS
IF-OF-IZ7015	Stair for 'H' Rig Configuration

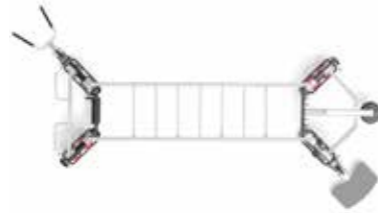

I-SHAPE RIG

IF-OF-I

DIMENSIONS	STATIONS	USERS
4794mm x 1654mm x 2490mm	2	9-11

The I-Shape rig configuration is slim and compact and allows for a lot of outside area to be brought into play. If space is at a premium the I-Shape rig is a perfect solution.

Although there are just two workout stations, there are a multitude of different station configurations which allow for greater personalisation and customisation.

CODE	REQUIRED CONNECTORS
IF-OF-IZ7008	Origin Functional Rig - Stair for I-Shape Rig (& L-Shape) Attachment

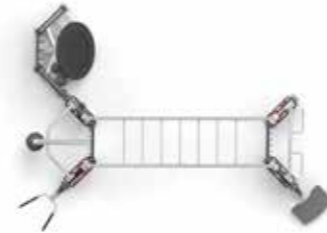

L-SHAPE RIG

IF-OF-L

DIMENSIONS	STATIONS	USERS
4794mm x 3250mm x 2490mm	3	8-10

The L-Shape functional rig configuration combines the best of an S-Shape & an I-Shape rig. The incorporation of a third workout station enables huge amounts of personalisation and customisation. This allows users to tailor the rig to meet specific workout needs and requirements.

The two adjacent workout stations are joined by an S-Joint Connector and the other station is joined with a ladder.

Despite not having an overhead ladder connector, the pull up handles on the stretch and DAP stations can still facilitate bodyweight and suspension training exercises.

CODE	REQUIRED CONNECTORS
IF-OF-IZ7008	Origin Functional Rig - Stair for I-Shape Rig (& L-Shape) Attachment
IF-OF-IZ7011	Origin Functional Rig - S-Joint Attachment



O-SHAPE RIG

IF-OF-O

DIMENSIONS	STATIONS	USERS
3590mm x 3473mm x 2447mm	4	9-12

The O-Shape rig configuration is similar to the H-Shape configuration. However, it has a little more open space between stations. This means that it takes up a little more floor area, but also offers increased training areas. Whilst the H-Shape rig only allows users to walkthrough the inside in one direction, the O-Shape rig features a crossroads style design.

The four stations face away from each other, ensuring any space between can be used for training, and are all joined together by a ladder.

CODE	REQUIRED CONNECTORS
IF-OF-IZ7014	Stair for 'O' Rig Configuration



S-SHAPE RIG

IF-OF-S

DIMENSIONS	STATIONS	USERS
1120mm x 3250mm x 2490mm	2	4-6

The S-Shape rig configuration is the most compact configuration there is. Consisting of only two stations and one S-Joint Connector, the S-Shape rig enables selections of two stations out of the five available. This means requirements can really be pinpointed and addressed in a small area.

The S-Shape rig, for its size, can be utilised in many different ways - especially when paired with the available attachments.

Note: The S-Shape rig cannot take the Half Rack station.

CODE	REQUIRED CONNECTORS
IF-OF-IZ7011	Origin Functional Rig - S-Joint Attachment

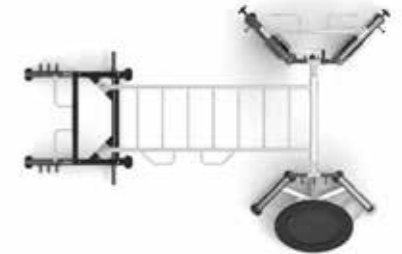

T-SHAPE RIG

IF-OF-T

DIMENSIONS	STATIONS	USERS
4694mm x 3139mm x 2490mm	3	9-12

The T-Shape functional rig consists of three workout stations, joined by the Single Connector and a ladder. With the choice of three stations from the five available there are lots of configurations available to address whatever needs or requirements a specific facility might have.

This rig configuration gives your facility a wide range of exercise options, but maintains enough space around each station for users to work underneath the ladder and move through between the arms of the T-shape.

CODE	REQUIRED CONNECTORS
IF-OF-IZ7006	Origin Functional Rig - Connector
IF-OF-IZ7007	Origin Functional Rig - Stair for X-Shape Rig (& T-Shape) Attachment

ORIGIN FUNCTIONAL RIG - DUAL ADJUSTABLE PULLEY STATION



DIMENSIONS	WEIGHT	USERS
2386mm x 957mm x 2365mm	380.5kg	2

Dual Adjustable Pulley's are considered one of the most versatile pieces of fitness equipment. The cable motion system, along with its height adjustability, various cable attachment options and weight stacks provides users with an almost endless array of options. Almost all muscle groups can be targeted with dual adjustable pulleys. Cable machines also have advantages over fixed resistance machines because they bring into play stabilising muscles.

PRODUCT CODE	ITEM	PRICE
IF-OF-IZ7005	Origin Functional Rig - Dual Adjustable Pulley Station	£2,886.54

ORIGIN FUNCTIONAL RIG - REBOUNDER STATION

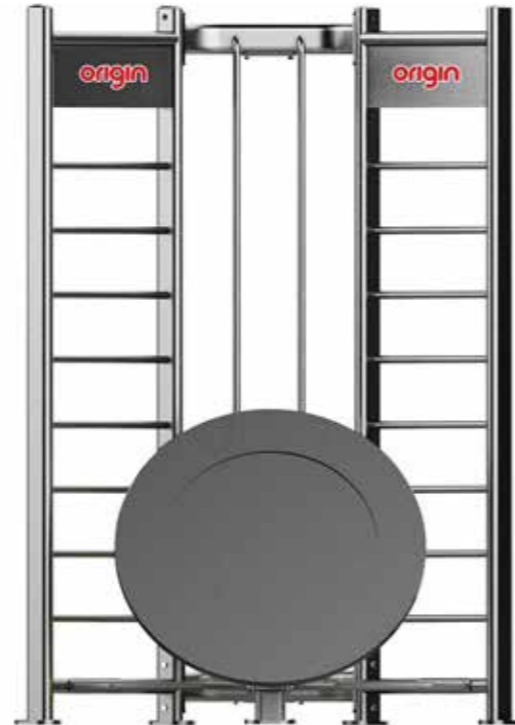

DIMENSIONS	WEIGHT	USERS
1655mm x 1072mm x 2340mm	153.6kg	2

Medicine ball and wall ball exercises play a large part in CrossFit WODs all around the world, so two of our favourite additions to functional rigs are overhead wall ball targets and ground level medicine ball rebounders. The Origin Fitness Functional Rig Rebounder Station has storage space for four medicine balls behind the rebounder.

PRODUCT CODE	ITEM	PRICE
IF-OF-IZ7003	Origin Functional Rig - Rebounder Station	£1,924.03

ORIGIN FUNCTIONAL RIG - STRETCH STATION

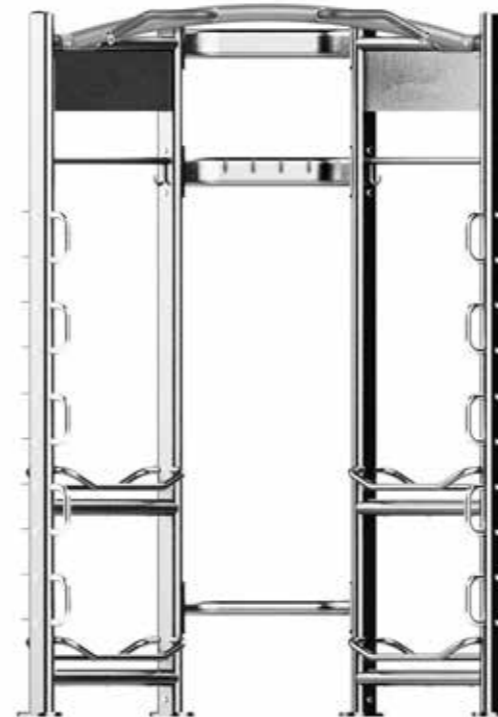

DIMENSIONS	WEIGHT	USERS
1655mm x 1126mm x 2377mm	135.9kg	3

The Stretch Station is a perfect addition to the functional rig offering. The incorporated shelves can be used for storage but are also important during exercises – and the multiple different heights offer a large range of workout options.

The vertical frame loops are perfect for threading through a battling rope or anchoring this type of equipment for dynamic exercises.

The stretch station also allows the attachment of the dip and plyo platform connectors, so is one of the most versatile stations on offer.

PRODUCT CODE	ITEM	PRICE
IF-OF-IZ7001	Origin Functional Rig - Stretch Station	£1,924.03

ORIGIN FUNCTIONAL RIG - BOXING STATION (EXCLUDES BOXING BAG)

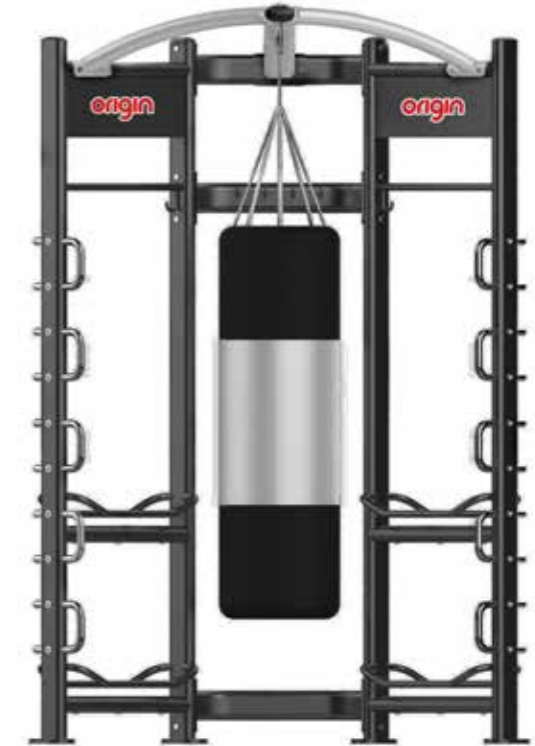

DIMENSIONS	WEIGHT	USERS
1655mm x 1126mm x 2377mm	135.9kg	3

The Origin Functional Rig Boxing Station offer many storage solutions, including shelves and hooks. These storage areas can keep tidy all kinds of accessories, including boxing gloves, mitts and pads, medicine balls and kettlebells.

Boxing bag not included.

PRODUCT CODE	ITEM	PRICE
IF-OF-IZ7002	Origin Functional Rig - Boxing Station	£1,924.03

ORIGIN FUNCTIONAL RIG - HALF RACK STATION



DIMENSIONS	WEIGHT	USERS
1747mm x 1409mm x 2443mm	167kg	3

The Origin Fitness Half Power Rack Station enables users to incorporate heavy lifting exercises into their functional training regime.

The Origin Fitness pivot attachments can also be incorporated into the rig at this station. The rack features 15 hook positions, spotter arms, j-hooks, storage bars and a pull up bar.

PRODUCT CODE	ITEM	PRICE
IF-OF-IZ7004	Origin Functional Rig - Half Rack Station	£1,924.03

ORIGIN FUNCTIONAL RIG - CONNECTOR



DIMENSIONS	WEIGHT
1528mm x 178mm x 205mm	13.9kg

The Single Connector joins together two workout stations and also has the option of connecting the Ladder + Connector in order to incorporate more workout stations into a rig configuration.

PRODUCT CODE	ITEM	PRICE
IF-OF-IZ7006	Origin Functional Rig - Connector	£143.42

STAIR FOR I-SHAPE RIG (& L-SHAPE)



DIMENSIONS	WEIGHT
3510mm x 1010mm x 206mm	43kg

The Ladder Connector can join together two workout stations and in the L-Shape rig it will connect three stations together.

The overhead bars alternate in height, increasing the effectiveness of the user's workout.

Suspension straps and resistance based equipment can also be hung from the bars allowing for a more varied workout.

PRODUCT CODE	ITEM	PRICE
IF-OF-IZ7008	Stair for I-Shape Rig (& L-Shape)	£481.22

STAIR FOR X-SHAPE RIG (& T SHAPE)

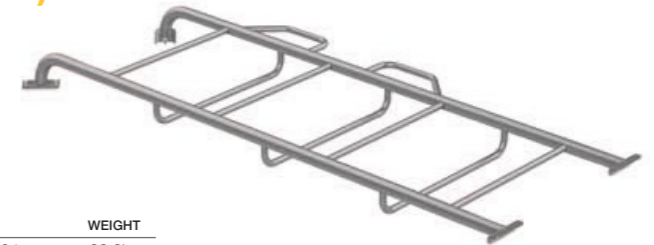

DIMENSIONS	WEIGHT
2850mm x 1117mm x 204mm	38.3kg

The Ladder + Connector allows configurations to vary in shape. On one side it will connect to one or two workout stations. On the other side it will connect to a Single Connector, which can connect directly to two more workout stations and another Ladder + Connector.

The overhead bars alternate in height, increasing the effectiveness of the user's workout.

Suspension straps and resistance based equipment can also be hung from the bars allowing for a more varied workout.

PRODUCT CODE	ITEM	PRICE
IF-OF-IZ7007	Stair for X-Shape Rig (& T Shape)	£480.28

LADDER CONNECTOR FOR O-SHAPE RIG



PRODUCT CODE	ITEM	PRICE
IF-OF-IZ7014	Ladder connector for O-Shape Rig	£404.24

LADDER CONNECTOR FOR H-SHAPE RIG



PRODUCT CODE	ITEM	PRICE
IF-OF-IZ7015	Ladder connector for H-Shape Rig	£404.24

ORIGIN FUNCTIONAL RIG - DIP ATTACHMENT



DIMENSIONS	WEIGHT
940mm x 624mm x 289mm	12.6kg

The Dip Attachment connects to the vertical parts of the frame on the boxing and stretch stations.

This adds additional value and functionality of these stations, and thus to the rig itself. Users can do bodyweight dips with this attachment. They can also be made easier/harder by incorporating extra weight or power bands into the workout.

PRODUCT CODE	ITEM	PRICE
IF-OF-IZ7010	Origin Functional Rig - Dip Attachment	£287.79

ORIGIN FUNCTIONAL RIG - STEP ATTACHMENT



DIMENSIONS	WEIGHT
749mm x 650mm x 289mm	16.3kg

Like the Dip Attachment, this hooks directly onto the hooks on the vertical frames of the boxing and stretch stations.

The height adjustability plays a key factor in these as they can be used as aerobic steps, or as plyometric platforms, which both benefit from differing height levels.

PRODUCT CODE	ITEM	PRICE
IF-OF-IZ7009	Origin Functional Rig - Step Attachment	£384.04

ORIGIN FUNCTIONAL RIG - CORE PLATE ATTACHMENT



DIMENSIONS	WEIGHT
530.5mm x 126mm x 178mm	5.9kg

Pivot points are great core trainers and are a strength training tool that can allow coaches to teach scalable versions of key compound and Olympic movements. These can often be found built into the feet of your rig or attached close to the ground.

PRODUCT CODE	ITEM	PRICE
IF-OF-IZ7012	Origin Functional Rig - Core Plate attachment	£95.29

ORIGIN FUNCTIONAL RIG - S-JOINT ATTACHMENT



DIMENSIONS	WEIGHT
178mm x 100mm x 50mm	2.6kg

The S-Joint Connector will join two workout stations adjacent to each other facing opposite directions.

This style of connector is ideal if space is at a premium as it creates a smaller rig footprint.

PRODUCT CODE	ITEM	PRICE
IF-OF-IZ7011	Origin Functional Rig - S-Joint Attachment	£47.16



SALFORD COMMUNITY CENTRE

“

From the initial meetings with Kenny and his ideas and conceptual drawing, the project was delivered on time, to budget and in such a professional manner that I would recommend Origin Fitness to any of my colleagues.

Marie Leather
Fit City Eccles
Salford Community Centre

”



PERFORMANCE RIGS

The Origin Performance Rig is our most simple and effective functional rig solution. Every essential feature in a functional rig – this setup has it covered. The performance rig option is perfect for CrossFit boxes or spaces where weightlifting space and pull up bars are a requirement. This allows you to configure a free-standing or wall mounted system with multiple squat racks, pull up stations, wall ball targets and even dipping/step stations.



ORIGIN PERFORMANCE FUNCTIONAL RIG – FREESTANDING

The Origin Performance Rigs are simple modular constructions with endless possibilities. Simply begin with a starter cell and add more cells and attachments to fit your needs. Rigs are made to order so full customisation is available, including colour, galvanisation, branding and attachments. Galvanising a rig may increase lead time.



STANDARD DIMENSIONS

Height	2700mm
Depth	1500mm

ORIGIN PERFORMANCE RIG – WALL MOUNTED



STANDARD DIMENSIONS

Height	2700mm
Depth	1500mm



Grappler Attachment



Bar Hooks (pair)



Additional Monkey Bar Attachment



Medicine Ball Target Attachment



3 Bar Wing Attachment



Vertical Weight Plate Storage Attachment



Dip Attachment



Step Attachment



High Bar Attachment

PRODUCT CODE	ITEM	PRICE
OF-PRG-FS001	Starter Cell	£1,663.20
OF-PRG-FS002	Additional Cell - 1050mm	£900.90
OF-PRG-FS003	Additional Cell - 1080mm	£900.90
OF-PRG-W001	Starter Wall Cell	£1,108.80
OF-PRG-W002	Additional Wall Cell 1.2m	£693.00
OF-PRG-W003	Additional Wall Cell 1.9m	£693.00
OF-PRG-A001	Grappler Attachment	£138.60
OF-PRG-A002	Bar Hooks (pair)	£221.76
OF-PRG-A003	Additional Monkey Bar Attachment	£110.88
OF-PRG-A004	Medicine Ball Target Attachment (1050mm)	£415.80
OF-PRG-A004-1	Medicine Ball Target Attachment (1800mm)	£415.80
OF-PRG-A005	3 Bar Wing Attachment (1050mm)	£429.32
OF-PRG-A005-1	3 Bar Wing Attachment (1800mm)	£336.00
OF-PRG-A006	Vertical Weight Plate Storage	£349.27
OF-PRG-A007	Dip Attachment	£277.20
OF-PRG-A008	Step Attachment	£304.92
OF-PRG-A009	High Bar Attachment	£277.20

PRODUCT CODE	ITEM	PRICE
OF-PRG-A010	Double Pull Up Bar - 32mm x 1050mm	£55.44
OF-PRG-A011	Rig Double Pull Up Bar - 32mm x 1500mm	£69.30
OF-PRG-A012	Double Pull Up Bar - 32mm x 1800mm	£83.16
OF-PRG-A013	Storage Rail Shelf 1050mm (each)	£110.00
OF-PRG-A013-1	Storage Rail Shelf 1500mm (each)	£115.00
OF-PRG-A013-2	Storage Rail Shelf 1900mm (each)	£120.00
OF-PRG-A014	Adjustable External Safety Spot Arms Attachment	£336.00
OF-PRG-A015	Adjustable Inverted Row Bar (1050mm)	£105.00
OF-PRG-A015-1	Adjustable Inverted Row Bar (1500mm)	£115.50
OF-PRG-A015-2	Adjustable Inverted Row Bar (1900mm)	£126.00
OF-PRG-A016	Multi-purpose Single Hoop Attachment	£44.10
OF-PRG-A017	Origin Performance Rig - Multi-purpose Triple Hoop Attachment	£52.50
OF-PRG-A018	Origin Performance Rig - Pull Up Handles Attachments	£117.60
OF-PRG-A019	Origin Performance Rig - 5m Climbing Rope	£152.00
OF-PRG-A020	Origin Performance Rig - Punch Bag Attachment	£210.00
OF-PRG-A021	Origin Performance Rig - Bar Holder Attachment	£74.00

**origin**[®]

MODULAR STORAGE RIGS

Our modular storage rig features combine functional rig essentials with the ultimate gym equipment storage system. Keep your gym safe and tidy with an fully customisable storage system which fits most gym equipment and accessories and also work your clients hard with features like the bridge, boxing, landmine and dipping attachments.

Bridge available in 3m, 5m and 7m.



FLAT SHELF
• Can also be used to hold up to four Sandbags



MEDICINE BALL SHELF
• Will hold five Standard Medicine Balls
• Will hold five Double Grip Medicine Balls
• Will hold three Oversized Medicine Balls



MAT HANGER
• Comfortably holds 25 mats on each set of poles

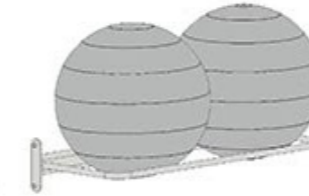

GYM BALL SHELF
• Will hold up to two 75cm Gym Balls



RAMP SHELF
• Can be used to hold up to nine foam rollers



AIR BALANCE TRAINER
• Holds up to five Air Balance Trainers



RAMP SHELF
• Will hold up to ten Dumbbells

ORIGIN MODULAR STORAGE RIG

Take your gym to the next level with custom storage and a versatile functional rig – all in a simple modular solution.

Our modular storage solution combines the versatility offered by functional rigs with a tailored and equally flexible gym equipment storage system.

Four cells shown - one cell minimum required.

Contact us today to discuss your options.



ViPR SHELF
• Comfortably holds six ViPRs



LARGE STORAGE BIN
• Used to store all kinds of small free weights & accessories



FLAT SHELF
• Will hold ten Kettlebells comfortably
• Can also be used to hold Sandbags or just as a flat shelf

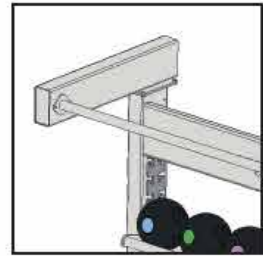
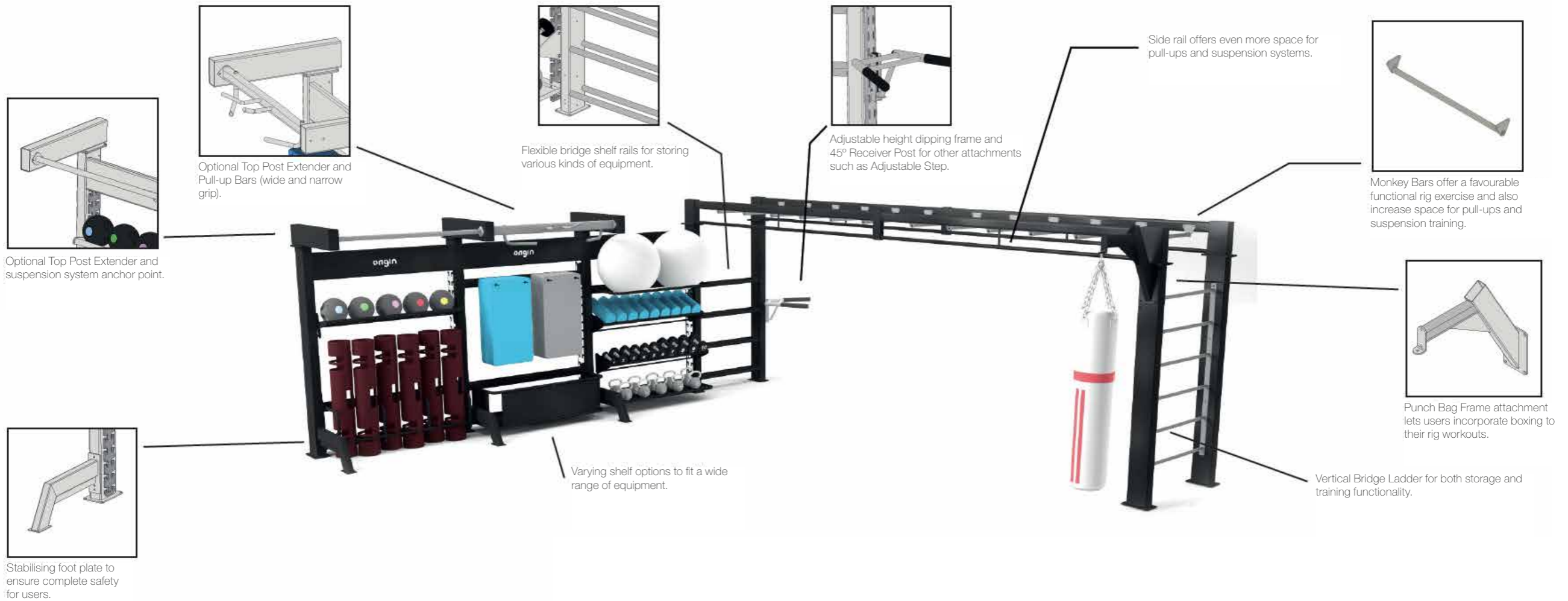

Optional Top Post Extender and suspension system anchor point.

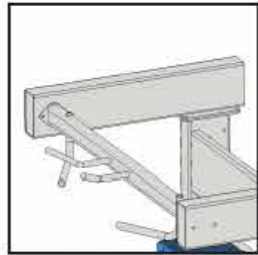

Optional Top Post Extender and Pull-up Bars (wide and narrow grip).

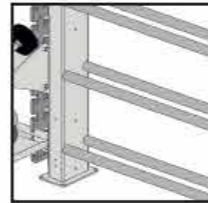

Flexible bridge shelf rails for storing various kinds of equipment.

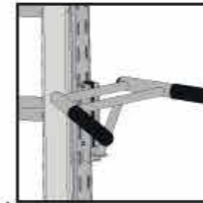

Adjustable height dipping frame and 45° Receiver Post for other attachments such as Adjustable Step.



Monkey Bars offer a favourable functional rig exercise and also increase space for pull-ups and suspension training.

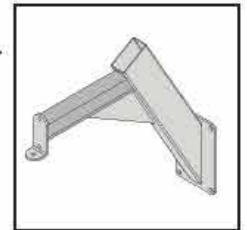

Punch Bag Frame attachment lets users incorporate boxing to their rig workouts.

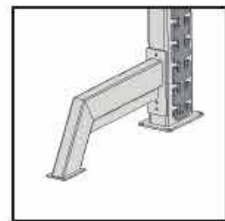

Stabilising foot plate to ensure complete safety for users.

Varying shelf options to fit a wide range of equipment.

Side rail offers even more space for pull-ups and suspension systems.

Vertical Bridge Ladder for both storage and training functionality.

Studio Barbell Storage

Allows each storage bay to hold up to 30 sets of studio barbell sets



Olympic Weight Plate Storage

Two methods of storing weight plates.



Origin Olympic Weight Plate Rack

Each pole is 200mm in length and can hold up to 5 bumper plates*

*Plate thicknesses will vary depending on type

Origin Olympic Weight Plate Toaster Rack

Will store up to 20 rubber bumper plates

SWEAT! GLASGOW

“

We had been working with Alan and the team at Origin Fitness since our first site and are looking forward to continuing the relationship on our future sites across the UK. Their knowledge and product range in functional training and flooring has been invaluable.

”

Jamie Mair
Sweat!
Glasgow



FUNCTIONAL

Our functional training equipment range has been developed to meet growing demand from members for well equipped cross training and functional zones within their gyms. With the brand range we offer our customers, we are sure we can help you create a highly functional space that maximises potential and delivers on all levels.

[Plyo Boxes](#)

[Sandbags](#)

[Kettlebells](#)

[Medicine Balls](#)

[Agility](#)

[Suspension](#)

[Training](#)

[ViPR®](#)

[Sleds](#)

[Other](#)



ORIGIN SOFT PLYO BOXES

The Soft Plyo Boxes enable powerful and dynamic plyometric exercises, without the risk of injury. The varying height options add varying degrees of difficulty to your workout.

The Origin Soft Plyo Boxes come in four varying heights which are perfect for beginners and experienced box jumpers alike. Box jumps are a great way to develop power, strength and cardio movement in any workout. What makes the Origin Soft Plyo Boxes perfect for all users is they remove the fear of injury which can be a real drawback in anyone's training.

- Great for dynamic plyometric exercises
- Soft shell reduces risk of injury
- Available in four different heights
- Stacked via secure Velcro straps
- Footprint: 89cm x 74cm

PRODUCT CODE	ITEM	PRICE
NTS-CG18-6	6" - Blue	£103.94
NTS-CG18-12	12" - Yellow	£173.24
NTS-CG18-18	18" - Green	£254.09
NTS-CG18-24	24" - Red	£334.94
NTS-CG18-SET	Soft Plyo Box Set (4 Boxes: 6,12,18, 24inch)	£866.20



ORIGIN SQYRE

Bringing the traditional bootcamp experience into the gym environment. The Sqyre takes functional fitness to the next level.

The Origin Sqyre is a multifunctional piece of equipment that gives you a wide variety of different workouts whilst being less intimidating than a standard rubber tyre. Due to the design the Origin Sqyre is much more predictable, than standard tyres when thinking about direction and stability, this means it can be used in classes or in close vicinity to other clients.

- Suitable for deadlifts, pushing, pulling, flipping, carrying and many other exercises
- Develops overall body strength
- Durable design
- 1090mm x 1090mm x 300mm

PRODUCT CODE	ITEM	PRICE
JFL-SQY-45	45Kg - Red	£1,097.25
JFL-SQY-60	60Kg - Blue	£1,212.75
JFL-SQY-80	80Kg - Green	£1,270.50



WOODEN PLYO BOX

The simple solid 18mm Plywood construction offers a hard wearing and extremely stable plyometric box option for gyms of all types.

- Solid 18mm Plywood construction
- Secure interlocking faced design
- Clear height identification in inches
- Multiple height options offer versatility and scaling options
- Flat packed with simple installation instructions

PRODUCT CODE	ITEM	PRICE
NTS-MPLYOB-01	Origin Wooden Multi Sided Plyo Box	£79.99



MULTI SIDED PLYO BOX

The Origin Multi Sided Plyo Box gives three box heights in the one product, allowing users to progress at their own pace whilst also saving space.

Designed to match standard sizes of traditional wooden plyo boxes and those used in CrossFit gyms around the world.

- Three plyo box heights in one product
- Standard dimensions used in CrossFit gyms and competitions
- Durable vinyl covering - easy to clean
- Soft foam core absorbs impact, reducing risk of injury
- Varying sizes allows users to progress whilst also saving space

PRODUCT CODE	ITEM	PRICE
NTS-MPLYOB-01	Multi Sided Plyo Box	£236.78



ORIGIN SANDBAGS

Each size of bag is colour coded for ease of identification so that all users use the correct weight that is right for them. Features two heavy duty end straps and two inner bags which hold the sand, with a foam inner lining.

Suitable for indoors and outdoor use.

- Great for performance & functional training
- Multi layering offers excellent durability and longevity
- Instability of bags recruits supporting muscles
- Weights range from 5kg – 30kg

PRODUCT CODE	ITEM	PRICE
NTS-TSPB5	5kg - Blue	£41.56
NTS-TSPB10	10kg - Purple	£47.24
NTS-TSPB15	15kg- Green	£51.62
NTS-TSPB20	20kg - Blue	£57.31
NTS-TSPB25	25kg - Red	£62.12
NTS-TSPB30	30kg - Grey	£72.60
NTS-SB5R	5 Sandbag/Alpha Bag Rack	£129.93



HIGHLAND BAGS



The Origin Highland Bags are sand filled, double stitched, nylon bags which can be used in many different ways.

The Origin Highland Bags are extremely versatile, allowing for new types of workouts as well as the ability to comfortably add weight to bodyweight exercises.

- Weight ranges from 5kg – 25kg
- Perfect for upper, lower & core strength training
- Soft design improves grip
- Moulds to your body shape

PRODUCT CODE	ITEM	PRICE
NTS-SA12-5	5KG	£23.49
NTS-SA12-10	10KG	£31.32
NTS-SA12-15	15KG	£43.06
NTS-SA12-20	20KG	£50.89
NTS-SA12-25	25KG	£61.86

BULGARIAN BAGS

Bulgarian Bags are available in X-Small to XX-Large, manufactured with pride in Bulgaria, and built with the toughness and durability to handle everything you can throw at them. Most, if not all of the exercises that can be performed with kettlebells, dumbbells, medicine balls, weight vests, and/or barbells can be performed with the Bulgarian Bag

PRODUCT CODE	ITEM	PRICE
OF-JFOBBTS3	Bulgarian Bag XS - 3kg	£161.69
OF-JFOBBTS5	Bulgarian Bag XS - 5kg	£161.69
OF-JFOBBTS6	Bulgarian Bag S - 6kg	£167.46
OF-JFOBBTS8	Bulgarian Bag S - 8kg	£167.46
OF-JFOBBTS10	Bulgarian Bag M - 10kg	£179.01
OF-JFOBBTS12	Bulgarian Bag M - 12kg	£188.25
OF-JFOBBTS14	Bulgarian Bag M - 14kg	£188.25
OF-JFOBBTS15	Bulgarian Bag L - 15kg	£234.45
OF-JFOBBTS17	Bulgarian Bag L - 17kg	£234.45
OF-JFOBBTS19	Bulgarian Bag L - 19kg	£234.45
OF-JFOBBTS20	Bulgarian Bag XL - 20kg	£282.96
OF-JFOBBTS22	Bulgarian Bag XL - 22kg	£292.20
OF-JFOBBTS26	Bulgarian Bag XL - 26kg	£292.20
OF-JFOBBTS30	Bulgarian Bag XXL - 30kg	£331.47
OF-JFOBBTS32	Bulgarian Bag XXL - 32kg	£331.47
OF-JFOBBTS34	Bulgarian Bag XXL - 34kg	£331.47



HYPERWEAR HYPER VEST PRO

The Hyper Vest PRO weighted vest is nothing less than revolutionary. The innovative design features a unique fabric control system that hugs the body for an extremely comfortable fit, like a compression shirt, but does not restrict range of motion.

The patented design flexes in the horizontal plane but not in the vertical plane. This allows for full chest expansion for breathing while keeping the weights in place even during vigorous, multi-plane movements.

- Unisex patented design for exceptional comfort
- Breathable, odour resistant, wicking fabric
- Open side panels provide superior ventilation
- Thin profile allows for full range of motion
- Flexible side lacing for highly-adjustable fit
- Comes pre-loaded with 4.5kg (10lbs) of steel weights

PRODUCT CODE	ITEM	PRICE
HYP-50	Medium Hyper Vest Pro	£155.83
HYP-21	Large Hyper vest Pro	£155.83
HYP-23	X-Large Hyper Vest Pro	£155.83
HYP-5	XX-Large Hyper Vest Pro	£155.83
HYP-6	Booster Pack	£31.66



HYPERWEAR SANDBELL

SandBells are great for all the traditional free weight and sand bag exercises as well as countless explosive power movements such as slams, tosses, and throws. Its versatility makes it ideal for many types of training from general strength and conditioning, to endurance based circuit as well as sports performance.

- Patented design works grip, wrist and forearms
- Shifting sand provides active live weight
- Extremeley durable, high quality design
- Multiple sizes available filled and unfilled
- Safe for all ages, levels and facilities

PRODUCT CODE	ITEM	PRICE
HYP-29	1kg (2lb) Sandbell	£10.32
HYP-30	2kg (4lb) Sandbell	£13.33
HYP-31	3kg (6lb) Sandbell	£15.83
HYP-32	3.5kg (8lb) Sandbell	£19.99
HYP-33	4.5kg (10lb) Sandbell	£23.33
HYP-34	5.5kg (12lb) Sandbell	£27.49
HYP-35	7kg (15lb) Sandbell	£34.16
HYP-36	9kg (20lb) Sandbell	£44.99
HYP-37	11kg (25lb) Sandbell	£54.99
HYP-38	14kg (30lb) Sandbell	£64.99
HYP-39	18kg (40lb) Sandbell	£83.32
HYP-40	23kg (50lb) Sandbell	£95.22



HYPERWEAR STEELBELL

The SteelBell is intense; there is just no other way to describe it. Constructed from extra-thick neoprene with a textured surface for improved grip and filled with steel shot, it packs a serious punch. Even though the SteelBell is twice as dense as the SandBell, it is still extremely safe for all ages and will not damage floor surfaces.

- Patented design works grip, wrist and forearms
- Shifting sand provides active live weight
- Extremeley durable, high quality design
- Multiple sizes available 2.5-90kg (5-200 lbs)
- Safe for all ages, levels and facilities

PRODUCT CODE	ITEM	PRICE
HYP-106	2.5kg (5lb) Steelbell	£23.81
HYP-105	4.5kg (10lb) Steelbell	£39.16
HYP-82	7kg (15lb) Steelbell	£54.99
HYP-81	9kg (20lb) Steelbell	£69.99
HYP-80	11kg (25kg) Steelbell	£85.83
HYP-79	14kg (30kg) Steelbell	£107.68
HYP-78	18kg (40lb) Steelbell	£142.83
HYP-77	23kg (50lb) Steelbell	£148.33
HYP-76	35kg (75lb) Steelbell	£198.38
HYP-69	45kg (100lb) Steelbell	£261.86
HYP-70	57kg (125kg) Steelbell	£325.34
HYP-71	70kg (150lb) Steelbell	£388.82
HYP-75	80kg (175lb) Steelbell	£452.30
HYP-74	90kg (200lb) Steelbell	£515.78



SANDBELL STORAGE CART WITH LID

This cart is constructed of a black powder-coated, heavy-duty wire frame upper cage mounted on a metal platform bottom. It includes 2 swivel & 2 rigid wheels and handle for easy portability. It also features a hinged wire lid that can be secured with padlock (not included).

With a 1,000lb capacity, the cart is able to store a large selection of SandBells or SteelBells

- Portable, 4-wheeled storage cart
- Wire cage construction on metal platform
- Attached lid for added security
- Holds up to 1000 lbs capacity
- Dimensions: 24" W x 36" L x 23" H

PRODUCT CODE	ITEM	PRICE
HYP-556	Hyperwear SandBell Storage Cart w/Lid	£317.40



HYPERWEAR SOFTBELLS

The most dynamic dumbbell on the market, the SoftBell adjustable dumbbell delivers a safe, versatile and effective workout to all users.

The SoftBell system consists of two soft neoprene weight plates that can be used individually or attached to an adjustable, easy-grip reinforced plastic handle to make a dumbbell. By attaching only one plate to the handle you can also use it similar to a kettlebell or clubbell.

- Patented 3-in-1 training system
- Soft weight plates prevent injury & damage
- Easy-grip reinforced plastic handle
- Breaks down for easy transport
- Multiple sizes from 1.4-9.1kg (3-20lb)

PRODUCT CODE	ITEM	PRICE
HYP-1501	1.4kg (3lb) Softbell	£19.84
HYP-1502	2.7kg (6lb) Softbell	£31.74
HYP-1503	4.1kg (9lb Softbell)	£39.68
HYP-1504	5.4kg (12lb) Softbell	£47.61
HYP-1506	6.8kg (15lb) Softbell	£55.55
HYP-1507	9.1kg (20lb) Softbell	£69.83



HYPERWEAR SANDROPE

The Sandrope is a 3.05m (10ft) long, 76.2mm (3") diameter neoprene tube filled with either 15 lbs or 30 lbs of sand. An anchor and collar are included (at no additional charge) so it can be used anchored like a traditional battle rope or free standing.

The patent pending design of the SandRope makes it as tough as traditional battling ropes, but without the shedding fibres. The 3.05m (10ft) Sandropes (14kg) are also as heavy as a 38.1mm diameter 15.2m (50ft) battle rope.

- Patented high quality, durable design
- Can be used anchored or unanchored
- Limited space needed
- Sand provides added resistance
- Great for individual or group training

PRODUCT CODE	ITEM	PRICE
HYP-801	7kg (15lb) Sandrope	£146.52
HYP-806	14kg (30lb) Sandrope	£128.33



KETTLEBELLS

Kettlebell classes are some of the most popular in gyms today, which is why it is important to us that you get the right product for you or your classes. The kettlebell workout is also one which has grown in popularity within the home sector. After learning the basics with an instructor or PT, we understand many people like to continue working with kettlebells in the privacy of their own home. There are five different types of kettlebells in the Origin range – cast iron, vinyl coated, rubber, urethane and competition.

COMPETITION KETTLEBELLS

Competition kettlebells are a standard size and shape. Ideal for those who have used kettlebells often and have developed their technique. The wide base is perfect for performing floor based exercises. Hollow steel offers the highest quality competition kettlebells available.

- Colour coded to differentiate weights
- High quality steel material
- Weights from 2kg – 32kg

PRODUCT CODE	ITEM	PRICE
NTS-CKB-04	4kg	£14.43
NTS-CKB-06	6kg	£21.64
NTS-CKB-08	8kg	£28.86
NTS-CKB-10	10kg	£36.57
NTS-CKB-12	12kg	£43.30
NTS-CKB-14	14kg	£51.00
NTS-CKB-16	16kg	£57.74
NTS-CKB-18	18kg	£65.44
NTS-CKB-20	20kg	£72.18
NTS-CKB-24	24kg	£86.61
NTS-CKB-28	28kg	£101.05
NTS-CKB-32	32kg	£115.49



RUBBER KETTLEBELLS

Not only does rubber coating the body of a kettlebell make the product more attractive, it also protects both the metal core and the floor from damage. Coloured coatings are useful for weight differentiation in gyms.

- Mid range kettlebells
- Rubber offers a more durable and long lasting kettlebell
- Attractive colour scheme
- Weight ranges from 4kg – 32kg

PRODUCT CODE	ITEM	PRICE
NTS-RKB-04	4kg	£15.70
NTS-RKB-06	6kg	£23.09
NTS-RKB-08	8kg	£29.56
NTS-RKB-10	10kg	£36.95
NTS-RKB-12	12kg	£39.26
NTS-RKB-14	14kg	£45.73
NTS-RKB-16	16kg	£52.19
NTS-RKB-18	18kg	£58.66
NTS-RKB-20	20kg	£65.13
NTS-RKB-24	24kg	£78.07
NTS-RKB-28	28kg	£91.00
NTS-RKB-32	32kg	£103.75



CAST IRON KETTLEBELLS

The Origin Cast Iron Kettlebells can be added to any weight training programme and are suitable for all fitness levels. However, when added to specialist training such as circuits, they can also help increase endurance and stamina.

- Great for entire body workouts
- 2kg – 32kg
- One of the most versatile pieces of fitness equipment
- Most affordable style of kettlebell

PRODUCT CODE	ITEM	PRICE
NTS-TS4014-2	2kg	£4.80
NTS-TS4014-4	4kg	£10.09
NTS-TS4014-6	6kg	£15.40
NTS-TS4014-8	8kg	£20.20
NTS-TS4014-10	10kg	£25.50
NTS-TS4014-12	12kg	£30.79
NTS-TS4014-14	14kg	£36.08
NTS-TS4014-16	16kg	£40.90
NTS-TS4014-18	18kg	£47.16
NTS-TS4014-20	20kg	£51.49
NTS-TS4014-24	24kg	£61.60
NTS-TS4014-28	28kg	£76.03
NTS-TS4014-32	32kg	£82.28
NTS-TS4014-36	36kg	£91.91
NTS-TS4014-40	40kg	£101.05



URETHANE KETTLEBELLS

The Origin Urethane Kettlebells are built to the highest quality. Urethane is highly durable and has the added bonus of not marking floors or equipment. The sleek dark grey design evokes quality and will fit into any gym environment effortlessly.

- Our most durable kettlebell
- Will not mark other equipment or floors
- Weights from 4kg – 32kg

PRODUCT CODE	ITEM	PRICE
NTS-UKB-G-04	4kg	£33.25
NTS-UKB-G-06	6kg	£42.49
NTS-UKB-G-08	8kg	£50.81
NTS-UKB-G-10	10kg	£69.29
NTS-UKB-G-12	12kg	£78.53
NTS-UKB-G-14	14kg	£92.39
NTS-UKB-G-16	16kg	£106.25
NTS-UKB-G-18	18kg	£116.41
NTS-UKB-G-20	20kg	£133.97
NTS-UKB-G-24	24kg	£157.07
NTS-UKB-G-28	28kg	£184.79
NTS-UKB-G-32	32kg	£212.51



KETTLEBELL SETS

Keep your functional or free weight environment fully loaded and organised with our Origin Kettlebell Sets. Our sets all contain the same ten weights of kettlebells throughout the range.

The Origin Kettlebell Sets contain:

- 1 x 4kg, 6kg, 8kg, 10kg, 12kg, 14kg, 16kg, 20kg, 24kg, 28kg Kettlebells
- 1 x Kettlebell Rack

CAST KETTLEBELL SET	
PRODUCT CODE	PRICE
NTS-CKBSR	£577.49
RUBBER KETTLEBELL SET	
PRODUCT CODE	PRICE
NTS-RUB-KBSR	£727.81
COMPETITION KETTLEBELL SET	
PRODUCT CODE	PRICE
NTS-COMPKBSR	£886.80
URETHANE KETTLEBELL SET	
PRODUCT CODE	PRICE
NTS-UKBSR	£1,257.73

KETTLEBELL RACK

Keeping your fitness area clean and organised can make a huge difference to your workout. Having a place for your equipment gives you piece of mind and will also increase the life of your kettlebells.

The two tier rack comes with durable rubber mats on each shelf which protects both the rack and kettlebell from damage.

Dimensions: 120cm x 55cm x 75cm

PRODUCT CODE	ITEM	PRICE
NTS-OKBR-02	Two Tier Kettlebell Rack	£192.48

ORIGIN MEDICINE BALLS

The Origin Medicine Balls are fantastic for targeting specific muscles during individual, group and functional training.

- Traditional but versatile piece of equipment
- Easy to grip finish
- Available in a wide range of weights and colours

PRODUCT CODE	ITEM	PRICE
NTS-TS1210-1	1kg	£17.80
NTS-TS1210-2	2kg	£21.17
NTS-TS1210-3	3kg	£25.50
NTS-TS1210-4	4kg	£28.39
NTS-TS1210-5	5kg	£31.28
NTS-MB1-5VR	1-5kg medicine ball set with vertical rack	£209.31



DOUBLE GRIP MEDICINE BALLS

The Origin Double Grip Medicine Balls allow for a different range of workouts to traditional medicine balls as the user is able to lift greater weights.

Keep your workout area organised with the Origin Medicine Ball Rack. Holds 5 Medicine Balls.

- Training aid for core strength, balance, stability, coordination, flexibility and speed
- Dynamic and versatile piece of fitness equipment
- Black textured finish, adds grip, making it safer to handle
- The colour coded design allows for easy identification

PRODUCT CODE	ITEM	PRICE
NTS-TS1211-6	6kg	£51.96
NTS-TS1211-7	7kg	£56.78
NTS-TS1211-8	8kg	£62.55
NTS-TS1211-9	9kg	£68.81
NTS-TS1211-10	10kg	£75.06
NTS-TS1219	5 Medicine Ball Rack (Silver)	£85.17
NTS-MB6-10VR	6-10kg double grip medicine ball set with vertical rack	£348.38



SLAM BALLS

The Origin Slam Balls are the perfect training tool for explosive slamming movements.

- Absorbs impact so they do not bounce
- Built to withstand repetitive high impacts
- Perfect for throwing against the floor and walls
- Textured outer layer provides users with added grip
- All weights, from 5kg to 15kg, are the same size

PRODUCT CODE	ITEM	PRICE
NTS-SB-5	5kg	£13.95
NTS-SB-7	7kg	£17.31
NTS-SB-9	9kg	£22.13
NTS-SB-12	12kg	£26.95
NTS-SB-15	15kg	£31.75



TORNADO BALLS

Tornado Balls are the ideal workout tool for users looking to perform fast and powerful rotational movements, helping to develop the core muscles.

- Adds a new dimension to your workout
- Improve core strength and stability
- Develop fast twitch muscle fibres
- Improve explosive power and agility
- Rubber surface texture medicine ball and a durable nylon rope

PRODUCT CODE	ITEM	PRICE
NTS-TOR-BALL-3	3kg	£32.08
NTS-TOR-BALL-4	4kg	£34.83
NTS-TOR-BALL-5	5kg	£38.49
NTS-TOR-BALL-6	6kg	£41.24
NTS-TOR-BALL-7	7kg	£44.91
NTS-TOR-BALL-8	8kg	£48.11
NTS-TOR-BALL-9	9kg	£55.91
NTS-TOR-BALL-10	10kg	£72.41



DYNAMAX
 AMERICAN MADE. ATHLETE APPROVED.

Dynamax brings athletic medicine ball training to the group fitness arena! Authentic high performance training methods to help your members train like athletes. Timed intervals combining locomotion, groundwork and rotation will help build the Dynamax 10 general physical skills. With the Dynamax 30-minute group formats your members can now experience what Dynamax means by "Fun Work. Hard Play."



Dynamax are widely regarded as the world's leading manufacturer of medicine balls. The standard 14" ball is a favourite tool of elite coaches at the highest level in sport.

- All Dynamax standard balls are 14" in diameter
- Moisture resistant covering
- Made from 70% post-consumer recycled material
- Dimensionally stable and balanced
- Each ball is handmade in the USA



PRODUCT CODE	ITEM	PRICE
DM-KB02	2kg	£71.40
DM-KB03	3kg	£76.65
DM-KB04	4kg	£80.85
DM-KB05	5kg	£86.10
DM-KB06	6kg	£96.60
DM-KB07	7kg	£100.80
DM-KB08	8kg	£105.00
DM-KB09	9kg	£111.30
DM-KB10	10kg	£116.55
DM-KB11	11kg	£120.75
DM-KB12	12kg	£134.40

ORIGIN ADJUSTABLE HURDLE

The Origin Adjustable Hurdles offer a flexible agility training tool as they quickly and easily adjust to two different height. An 180-degree turn of each leg will alter the height between either 20cm height or a 30cm heights.

- Ideal tool for speed and agility training drills
- Adjustable to two different heights - 20cm & 30cm
- Lightweight and easy to transport
- Wide footprint for stability
- Rubber feet for an enhanced grip

PRODUCT CODE	ITEM	PRICE
NTS-SA-CNS-01	Adjustable Hurdle	£10.07

ORIGIN HURDLE

The Origin Hurdle is ideal for sports teams, coaches and gyms looking to provide users/athletes a space for speed, functional or agility training.

The vibrant colour makes the hurdles easy to spot when at up in the gym making them easy for anyone to use and minimise the risk of them creating a trip hazard.

- Ideal tool for speed and agility training
- Lightweight
- Wide footprint for stability
- Rubber feet for an enhanced grip and safety
- Suitable for indoor and outdoor use

PRODUCT CODE	ITEM	PRICE
NTS-HRDLS-15	Hurdle 15cm	£6.29
NTS-HRDLS-23	Hurdle 23cm	£7.55
NTS-HRDLS-30	Hurdle 30cm	£8.81

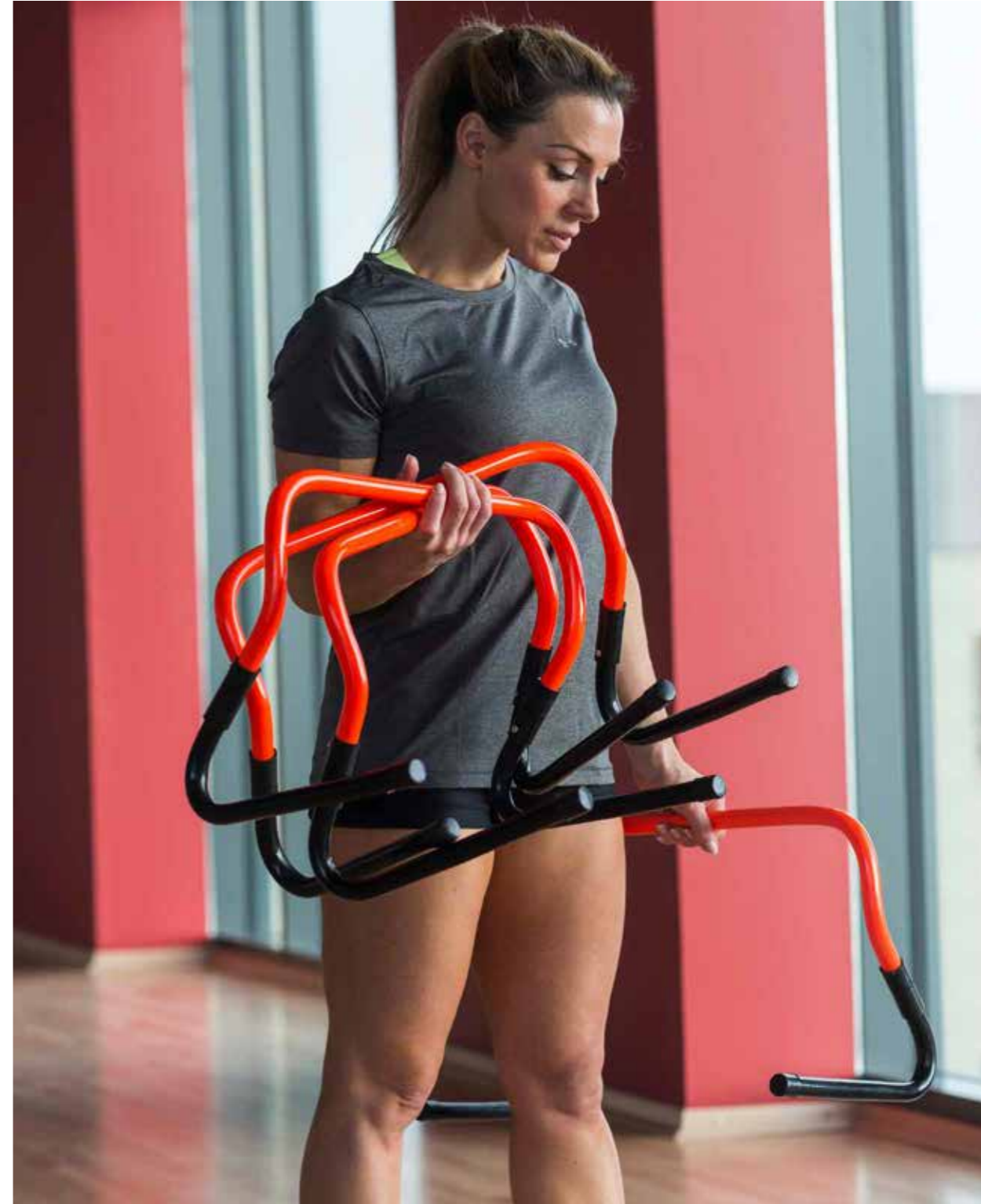
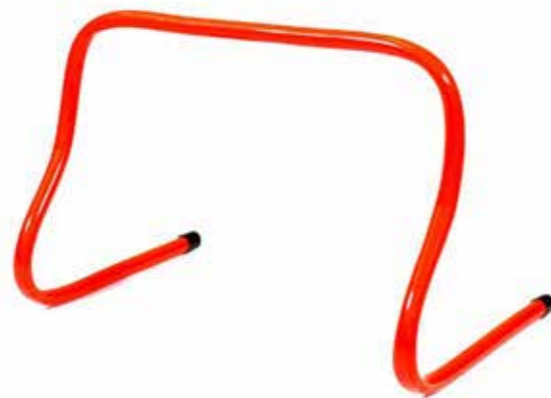

ORIGIN CONES WITH HOLDER

The Origin Marker Cones and Holder set are the perfect addition to any bootcamp and agility training toolkit. Made from a durable and bright plastic, the cones stand out on all surfaces and lighting conditions, allowing for flexibility and creativity in the programming of (the) workouts. Ideal for marking out spaces and zones to ensure group sessions are both safe and organised.

- 50 marker cones with holder included
- 10 sets of each colour
- Blue, Red, Yellow, Green and White coloured cones
- Great for speed and agility exercises
- Durable plastic material

PRODUCT CODE	ITEM	PRICE
NTS-SA-CNS-01	Cones with Holder	£30.62



ORIGIN SPEED LADDER

The Origin Speed Ladder is the perfect tool for indoor or outdoor speed and agility training. The ladder is lightweight making it easy to roll up, transport and set up for sessions in different spaces.

- Ideal training tool for speed and agility exercises
- Lightweight, portable design
- Available in various sizes to suit different requirements
- Adjustable ladders offer flexible training options
- Suitable for indoor and outdoor use

PRODUCT CODE	ITEM	PRICE
NTS-SPLDR-4M	4m	£10.07
NTS-SPLDR-5M	5m	£11.33
NTS-SPLDR-6M	6m	£12.59
NTS-SPLDR-7M	7m	£13.85
NTS-SPLDR-8M	8m	£16.37
NTS-SPLDR-10M	10m	£20.15



ORIGIN WOODEN OLYMPIC RINGS

The Origin Wooden Olympic Rings are sold in pairs and supplied with their own individual strap - easily adjustable to hang from any height. A smooth textured finish offers an ease of transfer, for example a muscle up.

- Sold in pairs and supplied with two straps
- Smooth textured grip
- Easily adjustable to hang from various heights - max length is 1.9m
- Simplistic design that will suit any commercial or home gym
- Great piece of gym equipment to enhance balance in various workouts

PRODUCT CODE	ITEM	PRICE
NTS-OLYRINGS-WD	Wooden Olympic Rings	£49.34



ORIGIN WALL MOUNTED PULL UP BAR

The Origin Wall Mounted Pull Up Bar comes in either 1.5m or 2m lengths with 90cm of clearance from the wall. This allows users to safely and effectively do pull up or suspension based exercises from the bracket. The M12 size holes allows secure wall fastening.

- Takes your body to a new level of strength & endurance
- 34mm steel construction
- Easily connects to suspension trainer straps allowing easy installation anywhere
- Progress through a multitude of workouts

PRODUCT CODE	ITEM	PRICE
OF-WMPUB-1-5	1.5m	£225.21
OF-WMPUB-2	2m	£226.37

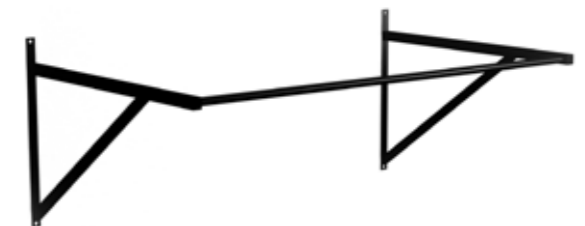

PT4PRO SUSPENSION TRAINER

The PT4Pro® is a portable, lightweight suspension training tool to aid weight loss, stability, flexibility, strength and stamina – and can be used virtually anywhere. The PT4Pro®'s versatility provides an effective workout for every muscle group within 30 minutes, at whatever level you want. The PT4Pro® is used by fitness centres, fitness professionals and in personal home training. The PT4Pro® personal trainer comes with a stylish travel bag, so you can take it with you wherever you like!

Includes:

- 2 handles
- 1 anchor line
- 2 adjustable straps / lines
- A travel bag
- Getting Started guide, plus safety door mount

PRODUCT CODE	ITEM	PRICE
PT4PRO	PT4Pro Suspension Trainer	£86.58



PT4PRO ROTATIONAL PULLEY SUSPENSION SYSTEM

The PT4Pro® Rotational Pulley is a powerful tool that allows you to get the most out of your workout. It allows you to simultaneously train and strengthen your core and sense of balance, due to the upper body turning exercise. The rotational factor adds another dimension to your workout and ensures optimal training of multiple muscle groups. The Rotational Pulley is easy to use combined with the suspension anchor and handles of the PT4Pro® Suspension Trainer.

- Easily attachable
- Adds a unique additional dimension to your workout
- Heavy-Duty Construction.
- Full 12-month warranty

PRODUCT CODE	ITEM	PRICE
PT4PRO-RP	PT4Pro Rotational Pulley Suspension System	£76.90



PT4PRO OLYMPIC RINGS

The PT4PRO® Olympic Rings will transform the way you work out. The Olympic Rings allow you to carry out so many more gymnastic exercises – they're strong, comfortable and provide a lot of grip.

- Takes your body to a new level of strength & endurance
- Easily connects to suspension trainer straps allowing easy installation anywhere
- Progress through a multitude of workouts

PRODUCT CODE	ITEM	PRICE
PT4PRO-OR	PT4Pro Olympic Rings	£28.86



LIFT THE BAR

“

I actually consider Origin Fitness more of a service provider than an out and out retailer, the support and advice they have given as well as the aftersales support they provide is unlike anything I have experienced in any sector.

”

Chris Burgess
Lift The Bar

TRX[®] PRO SUSPENSION TRAINER

The TRX[®] Pro Suspension Training Kit features the strongest, most durable Suspension Trainer TRX[®]

- Door Anchor
- Suspension Anchor
- Xtender
- Allen Wrench
- Trainer Specific instructional workout cards, six mix and match workout sessions, and two bonus workouts for your clients

PRODUCT CODE	ITEM	PRICE
FDS-TRXPRO4	TRX [®] Pro Suspension Trainer	£229.85



XMOUNT[™]

The TRX[®] Xmount[™] is a small and sturdy piece of hardware that provides an easy anchor point for your TRX Suspension Trainer. Measuring just 4.5" in diameter, this high quality steel plate easily attaches to any wall, vertical stud or secure overhead beam and supports all TRX[®] Suspension Trainer models. Now you can turn any room in to a home gym.

PRODUCT CODE	ITEM	PRICE
TRX-TRXXMOUNT2	TRX [®] Xmount [™]	£32.03





ViPR™ is designed to provide an effective, complete body workout, which builds muscle and burns calories through strength and movement training.

- Can be lifted, pulled, dropped or slammed
- Developed from a need for purposeful motion & functional movements
- Incorporates twisting & lateral movements
- Weights from 4kg – 26kg

PRODUCT CODE	ITEM	PRICE
D2F-VIPR-4	4 Kg	£115.50
D2F-VIPR-6	6 Kg	£127.05
D2F-VIPR-8	8 Kg	£144.38
D2F-VIPR-10	10 Kg	£168.43
D2F-VIPR-12	12 Kg	£202.13
D2F-VIPR-16	16 Kg	£211.75
D2F-VIPR-20	20 Kg	£245.44
D2F-VIPR-26	26 Kg	£303.19
D2F-VIPR-PT	PT Rack - Holds 20-30 ViPR and up to 200kg Suitable for all ViPR weights	£349.05
D2F-VIPR-VGF	VGF Rack - Holds approx 30 ViPR and up to 300kg Suitable for 4kg, 6kg and 8kg ViPR	£520.24



ORIGIN DRAG SLED

The Origin Drag Sled is a great tool for strength and conditioning purposes. Whilst primarily targeting legs, arms and hip strength, the Origin Drag Sled also offers a complete body workout and can be used in High-Intensity Interval Training to really push your body to its limits.

The durable design will withstand full commercial usage. The central plate loading point will hold all Olympic sized plates and keeps the sled balanced.

- Rope hoop allows sled to be pulled or dragged
- Easily transportable and suitable for any terrain
- Attach a harness, battle rope or pull rope to the hoop
- 140kg load capacity
- Chamfered edges prevents the sled catching and damaging turf

PRODUCT CODE	ITEM	PRICE
OF-2710	Origin Drag Sled	£129.99



ORIGIN PROWLER

The Prowler sled can be used either indoor or outdoor, on a variety of different surfaces. Sled pushing is one of the most effective and efficient exercises for a full body workout.

The prowler comes with two detachable vertical poles which allow users to adjust their centre of gravity to target different muscle groups.

The front of the prowler has two separate horizontal pole sets which allows users to push back along a track without turning the sled. Users can also hook a harness or strap around these poles and pull the sled, allowing for a more versatile workout.

PRODUCT CODE	ITEM	PRICE
OF-2715	Origin Prowler	£345.99



ORIGIN PERFORMANCE DOG SLED

The Origin Performance Dog Sled is the perfect tool for sled work in all types of facilities. The full-height handles on both sides allow quick change-overs between multiple users or fast changes in the direction it's being pushed – great where space is limited. The double sided handles even allow multiple users to push against each other at the same time.

Our Performance Dog Sled also comes with a useful rope attachment that makes it perfect for pulling using a battle rope or even attaching a harness to the user.

PRODUCT CODE	ITEM	PRICE
OF-2720	Origin Performance Dog Sled	£649.99





THE TANK

The TANK™ is a must-have product in the pursuit to build the perfect athlete. If you are looking for a complete workout then this exercise sled is perfect for you. With three different difficulty levels, all users are able to challenge themselves every time they use the TANK™.

- 4 Pneumatic Tyres
- Variable magnetic resistance
- Compatible with all surfaces
- Bi-directional - the resistance works both pushing & pulling. No need to turn the tank around.
- Two weight plate holders

PRODUCT CODE	ITEM	PRICE
MT3-XTT1	Torque Tank	£1,495.00



ORIGIN WEIGHTED VESTS

The Origin Weighted Vest is available in three different weight options; 10kg, 15kg and 20kg. Each vest is designed to fit all users with a single size design.

Small pockets of sandbags distributed evenly throughout the vest allow the Origin Weighted Vest to be worn comfortably and securely while avoiding sagging and tearing of material over time. This even weight distribution allows the wearer to perform movements more naturally without being pulled off balance.

A pull-over design makes it easy to get in and out of the vest, while the Velcro strap allows the user to tighten and secure the vest to fit perfectly.

- Available in three different weight options
- Evenly distributed weighted sections
- Individual weights can be removed
- Comfortable fit - one size fits all
- Easily fastened with velcro support

PRODUCT CODE	ITEM	PRICE
NTS-WTDVST-10	Origin Weighted Vest 10kg	£81.36
NTS-WTDVST-15	Origin Weighted Vest 15kg	£109.37
NTS-WTDVST-20	Origin Weighted Vest 20kg	£131.24



ORIGIN AB MAT

Take your core workouts to the floor with the Origin Ab Mat. Built to last, the Origin Ab Mat can be used safely for all types of abdominal workouts, due to its vinyl covering, foam core and non-slip base. One size fits all to make sure it is perfectly suited for solo as well as circuit based sessions.

- Enables full flexion of the spine which ensures a full abdominal workout
- Available in one standard size
- Foam core with durable vinyl covering
- Easy wipe clean surface and non-slip base
- Lightweight and portable

PRODUCT CODE	ITEM	PRICE
NTS-ABMAT-01	Ab Mat	£15.74



ORIGIN 15M POWER ROPE WITH COVER

The Origin 15m Power Rope with cover is a brilliant functional accessory for gyms and clubs.

- Strong nylon cover adds improved durability to our standard rope
- Work on core strength, power, speed and endurance with a wide range of exercises
- Suitable for use outside in bootcamp style classes
- Ridged plastic covered ends make it easy to keep a hold of the rope

PRODUCT CODE	ITEM	PRICE
NTS-BRC-25	25mm Thick with nylon cover	£75.00
NTS-BRC-42	42mm Thick with nylon cover	£149.00

ORIGIN FUNCTIONAL BLOCK

This 25kg utility block can be used for anything from step-up, bench, agility drills, carrying and throwing. The blocks are a diverse tool and feature ridges at each end allowing the blocks to align when they are used in lines of more than one. The Functional Block also features inset handles which makes moving the blocks safe and easy.

DIMENSIONS	WEIGHT
610.5mm (L) x 230mm (H) x 350mm (W)	25kg

PRODUCT CODE	ITEM	PRICE
ILP-FBLOCKS-25KG	Functional Block	£108.90



ORIGIN POWER BANDS

The Origin Power Bands are extremely useful for fitness enthusiasts as they are easy to transport and their versatility allows for use almost anywhere for a variety of training goals.

Used to increase strength, balance, flexibility and mobility

- Bands vary from light (13mm) to heavy (83mm)
- Bands are 106cm in length
- Suitable for adding gradually intensifying resistance to strength training movements

Available in the following six sizes and colours: 13mm blue, 21mm purple, 32mm orange, 45mm green, 64mm red

PRODUCT CODE	ITEM	PRICE
NTS-TS1104B-BE-13	13mm	£7.42
NTS-TS1104B-PE-21	21mm	£11.16
NTS-TS1104B-OE-32	32mm	£16.17
NTS-TS1104B-GN-45	45mm	£25.36
NTS-TS1104B-RD-64	64mm	£34.11
NTS-TS1104B-BE-83	83mm	£45.49



ORIGIN WALL MOUNTED BATTLE ROPE HOLDER

The Origin Wall Mounted Battle Rope Holder is a simple yet stylish storage solution for any functional zone. By storing battle ropes on the walls, you create a safer, more spacious and flexible functional training area while keeping the ropes easily within reach.

The holder will support all battle rope sizes, from 25mm to 42mm and can even be used for other equipment such as power bands, skipping ropes or belts.

Wall fixings included.

- Keeps battle ropes off the gym floor
- Help maintain battle rope condition
- Sleek powder coated steel design
- Lightweight and durable
- Wall fixings included

PRODUCT CODE	ITEM	PRICE
NTS-BRH-01	Wall Mounted Battle Rope Holder	£19.99



FIT CITY ECCLES

“

I have worked with Kenny from Origin Fitness for the past six years and he is my “go to man” if I want any equipment advice for either the studios or the gyms. I also value his insight to what’s happening in the industry and how he can assist Salford Community Leisure stay abreast of an ever-changing industry.

Marie Leather
Fit City Eccles
Salford Community Leisure

”

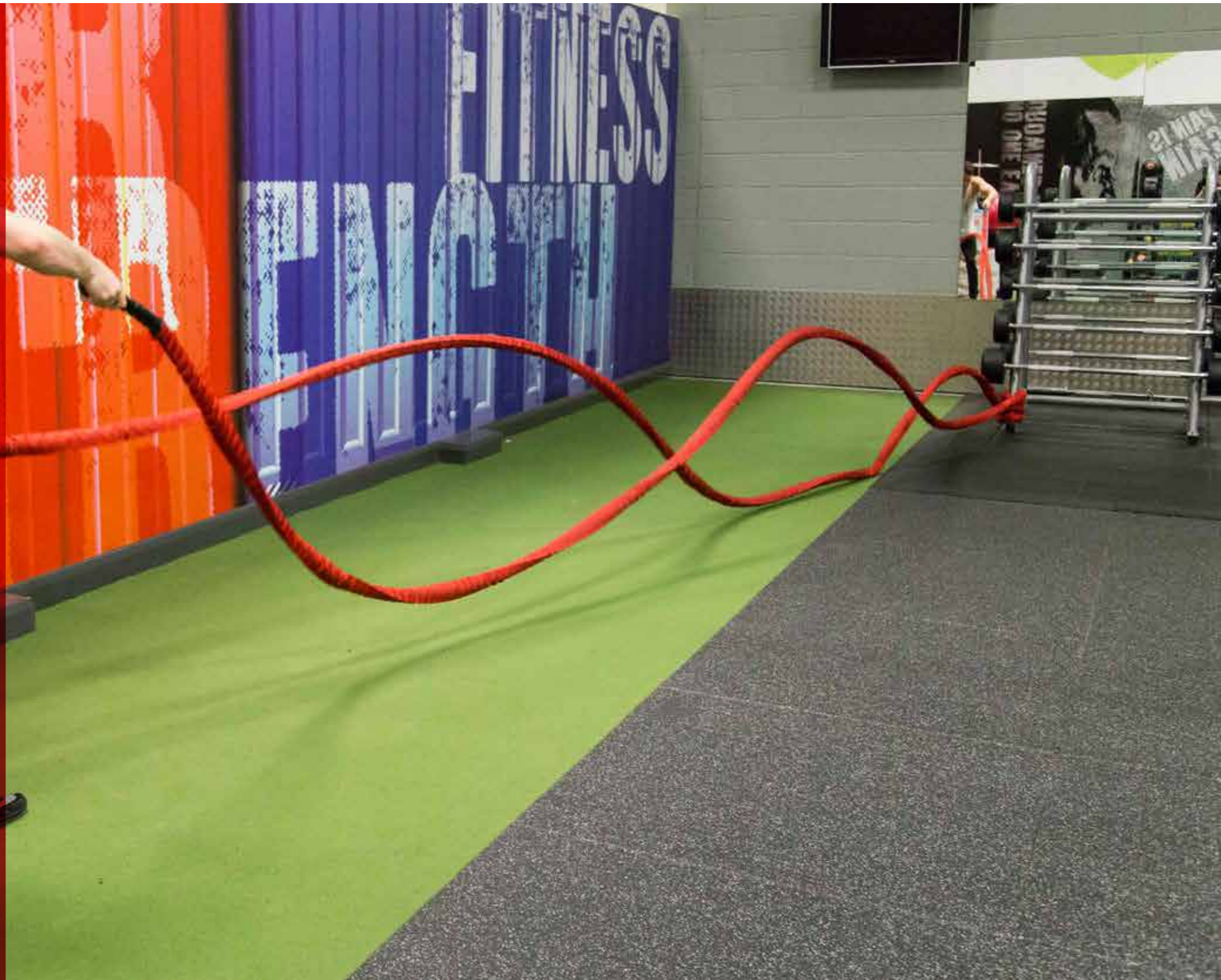

STUDIO EQUIPMENT

Origin's studio accessories range includes great products designed and manufactured with users and studios in mind.

With additional products available from Reebok, our studio offering has something for everyone, from beginners to advanced users.

[Studio Dumbbells](#)

[Studio Weight Sets](#)

[Fluidity Barre](#)

[Mats](#)

[Steps](#)

[Stability & Gym Balls](#)

[Foam Rollers](#)

[Other](#)



ORIGIN VINYL STUDIO DUMBBELLS

The Origin Studio Dumbbells are sold in pairs and feature an anti-roll design, allowing for greater functionality & convenience.

- The weights are differentiated by bright, bold colours to bring out the best in your studio or home
- Each dumbbell is marked with the specific weight (kg)
- The vinyl covering means the dumbbells wipe clean

PRODUCT CODE	ITEM	PRICE
NTS-TS4001-05	Vinyl Studio 2 x 0.5kg Dumbbells (Sky Blue)	£2.40
NTS-TS4001-1	Vinyl Studio 2 x 1kg Dumbbells (Purple)	£5.09
NTS-TS4001-2	Vinyl Studio 2 x 2kg Dumbbells (Red)	£10.09
NTS-TS4001-3	Vinyl Studio 2 x 3kg Dumbbells (Lime Green)	£15.40
NTS-TS4001-4	Vinyl Studio 2 x 4kg Dumbbells (Yellow)	£20.69
NTS-TS4001-5	Vinyl Studio 2 x 5kg Dumbbells (Blue)	£25.98



ORIGIN VINYL STUDIO DUMBBELL & RACK

The Origin Studio Dumbbell Rack offers users a great storage solution for the Origin Studio Dumbbells. The rack will hold up to 42 pairs of the Origin Studio Dumbbells (specific dumbbell configuration required).

The 42 Pair Dumbbell Set consists of 3 x 5kg, 3 x 4kg, 8 x 3kg, 10 x 2kg, 10 x 1kg and 8 x 0.5kg dumbbells.

PRODUCT CODE	ITEM	PRICE
NTS-TS5025	Studio Dumbbell Rack	£298.37
NTS-SDBS	Studio Dumbbell Set with Rack	£712.24



ORIGIN URETHANE STUDIO BARBELLS, WEIGHTS & COLLARS

Our Origin Studio Plates feature a dual grip design perfect for exercises without using the barbell. Plates can be purchased individually or in sets as shown below. The Origin Studio Barbell comes with Origin Studio Barbell Spring Collars. The Origin Studio Barbell Set is an excellent option both for strength training during PT and open gym as well as group fitness and studio weights classes.

PRODUCT CODE	ITEM	PRICE
NTS-SWPS	Origin Urethane Studio Weight Plate Set	£134.48
NTS-SWPS-10	Origin Urethane 10 x Studio Barbell Set with Rack	£1,510.97
NTS-SWPS-20	Origin Urethane 20 x Studio Barbell Set with Rack	£2,944.94
NTS-SWPS-30	Origin Urethane 30 x Studio Barbell Set with Rack	£4,756.84



ORIGIN RUBBER STUDIO BARBELL SET

Origin Fitness Rubber Studio Weights are incredibly hard wearing and versatile tool for all of your studio weights and group exercise sessions. Each plate has a solid iron core construction with a protective outer rubber layer. Each set comprises of a bar, collars and three pairs of weight discs. The weights disc pairs included are 1.25kg, 2.5kg and 5kg.

- Durable core with rubber coating
- Bold colours to help with weight identification
- Tactile and ergonomic handles provide excellent grip
- Comes complete with studio bar and spring collars
- Also available with racks in sets of 10, 20 and 30

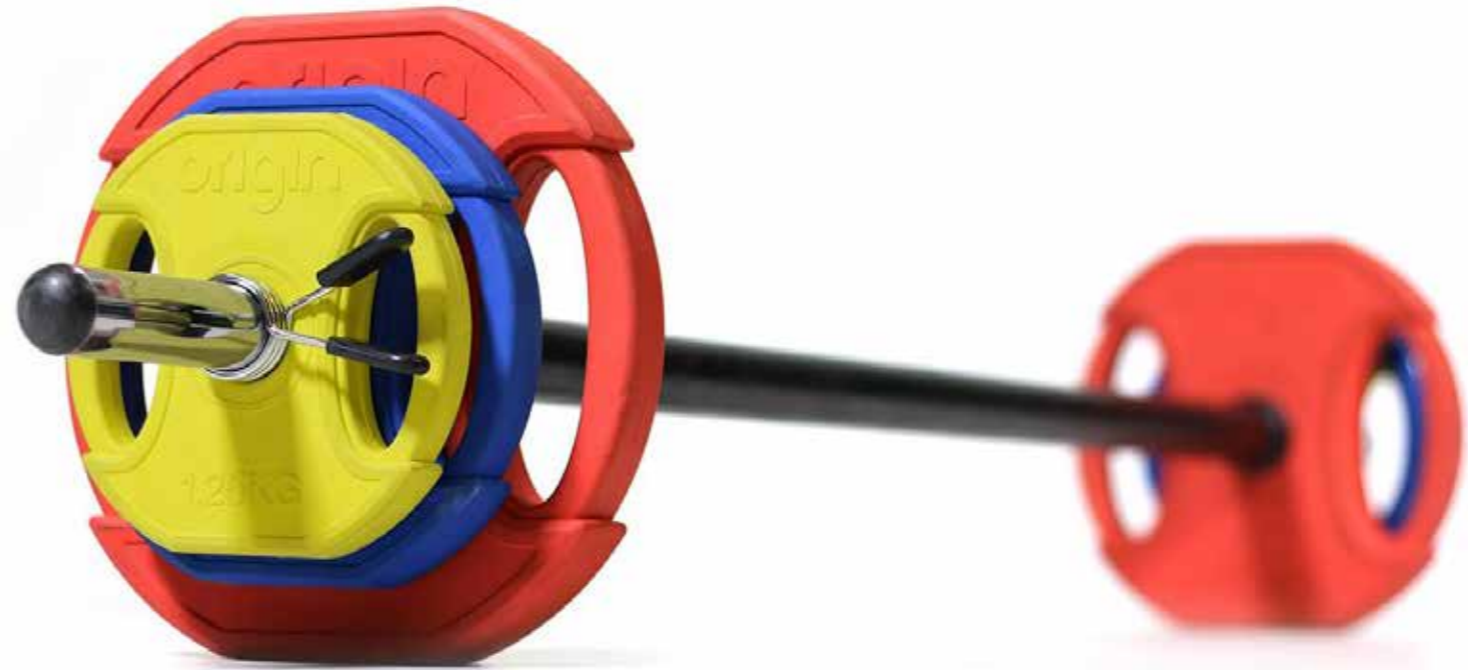

PRODUCT CODE	ITEM	PRICE
NTS-RSWPS	Origin Rubber Studio Barbell Set	£77.00
NTS-RSWPS-10	Origin Rubber 10 Studio Barbell Set with Rack	£950.00
NTS-RSWPS-20	Origin Rubber 20 Studio Barbell Set with Rack	£1,800.00
NTS-RSWPS-30	Origin Rubber 30 Studio Barbell Set with Rack	£2,750.00



ORIGIN STUDIO RACKS

PRODUCT CODE	ITEM	PRICE
NTS-SBR-10	Origin 10 Set Studio Barbell Rack	£182.87
NTS-SBR-20	Origin 20 Set Studio Barbell Rack	£288.74
NTS-SBR-30	Origin 30 Set Studio Barbell Rack	£385.00

FLUIDITY BALLET BARRE

The Fluidity Barre is the world's first height-adjustable ballet barre to feature the strength and rigidity of a wall-mounted barre in a completely portable, freestanding unit. Its patented design allows you to work against the resistance of your own body weight and the barre in all directions – the key to developing whole-body strength and flexibility and the long, lean lines of a dancer's body.

Features:

- Dual user design maximizes floor space
- Luxurious custom turned solid ash barre
- Independently adjustable barre height for dual users
- Rubberized over-moulding on all touch points to prevent slippage during usage
- Cushioned backboard simulates working against a wall
- Easy "push-push" mechanism to lock and release leg
- 4x swivel wheels for ultimate portability
- Legs stow securely in place during transport

Specification:

- Structural steel frame members
- Welded and mechanically fastened construction for unit stability
- Lightweight aluminum alloy columns with high strength to weight ratio
- Robust and corrosion resistant powder coat finish resists flaking and chipping
- Metallic silver coloration
- High strength, easily cleanable vinyl mat covering
- High density internal mat padding
- Barre height adjustability from 32 inches to 43 inches
- Maximum user weight 300 lbs

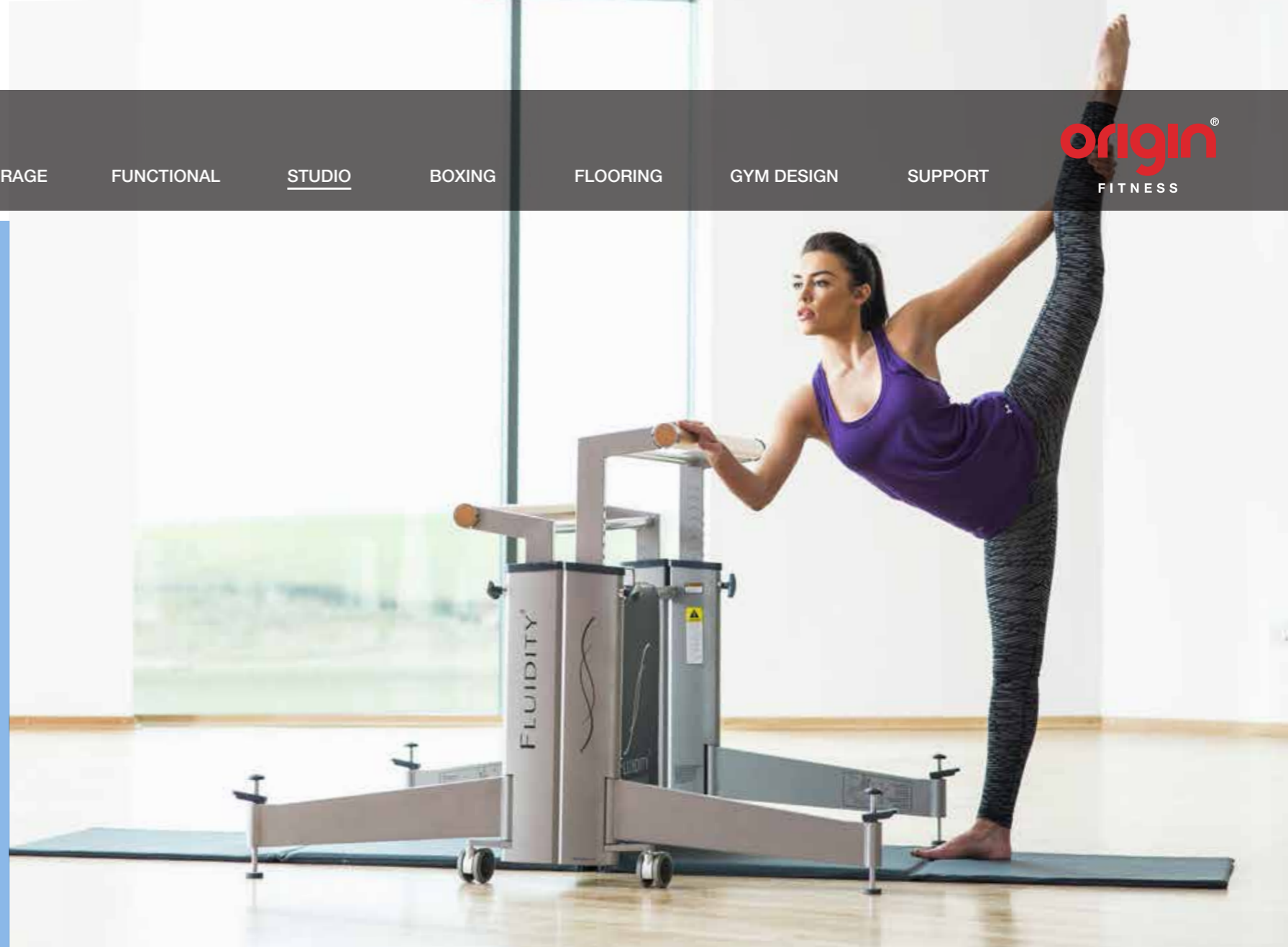

PRODUCT CODE	ITEM	PRICE
FIL-1950	Single User Ballet Barre	£1,055.50
FIL-1901	Dual User Student Barre	£1,140.72

ORIGIN VINYL FITNESS MAT

- Durable non-slip Vinyl surface material with foam core
- 10mm thickness allows for a variety of uses
- Wipe clean surface helps increase mat life
- Eyelets allow mats to hang vertically on hangers
- 36cm apart

DIMENSIONS

61cm x 173cm x 0.4cm

PRODUCT CODE	ITEM	PRICE
NTS-VM-V1-GY	Origin Vinyl Mat - Grey	£23.61
NTS-VM-V1-BE	Origin Vinyl Mat - Blue	£23.61

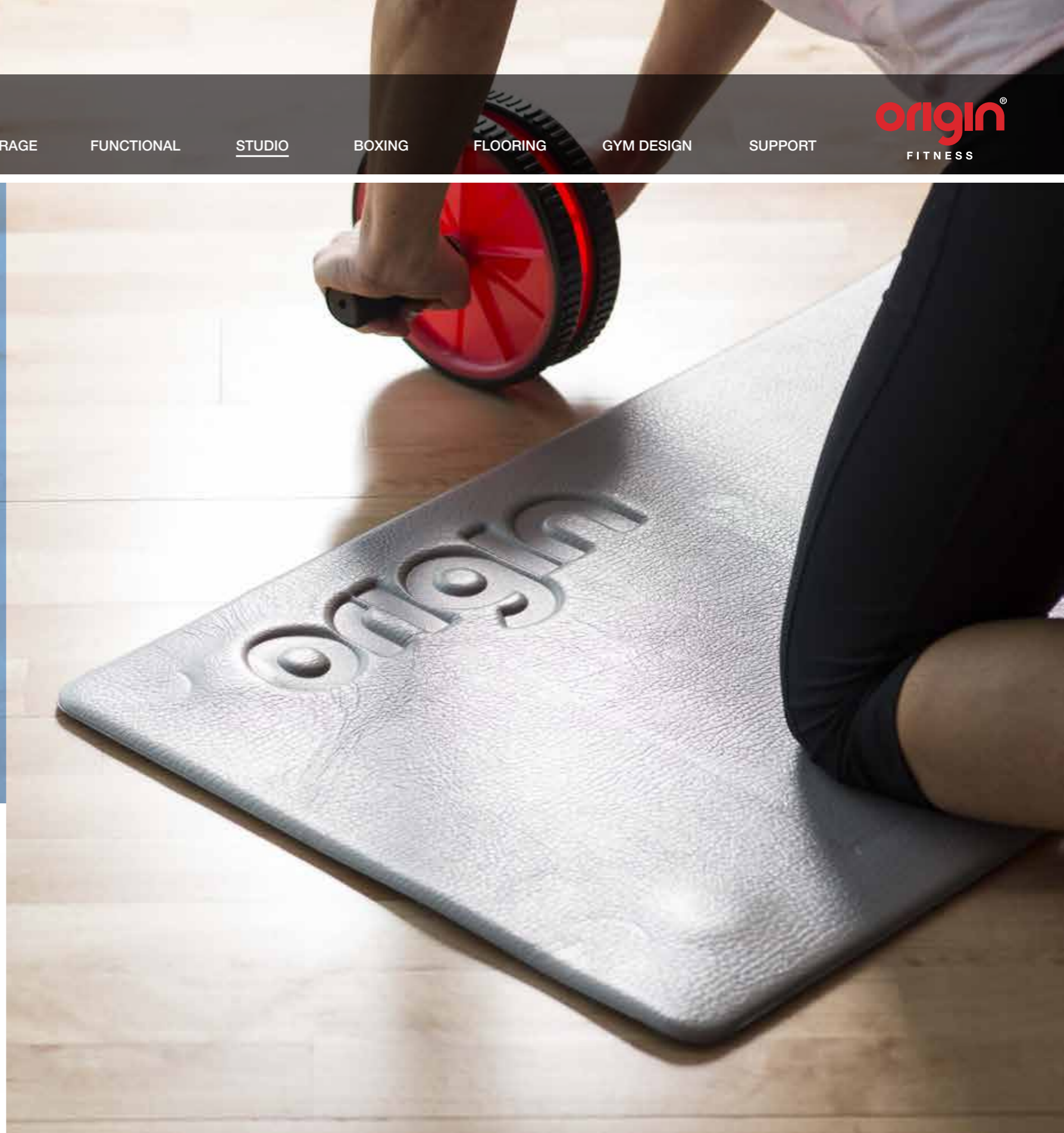

ORIGIN YOGA MATS

- Made from PVC
- Textured surface gives more grip
- Cushioning system makes for a more comfortable workout
- Lightweight – great for taking to and from classes
- Eyelets allow mats to hang vertically on hangers - 36cm apart

DIMENSIONS

61cm x 173cm x 0.4cm

PRODUCT CODE	ITEM	PRICE
NTS-YM-V2-B	Blue Yoga Mat with Eyelets	£8.70
NTS-YM-V2-P	Purple Yoga Mat with Eyelets	£8.70

ORIGIN PILATES MATS

- Made from dense PVC
- A grippy yet soft surface that is lightweight and quick drying.
- 6mm thick for extra comfort during your Pilates workout.
- Excellent cushioning and heat sealed edges for longevity
- Can be rolled up for easy transportation and storage.
- Eyelets allow mats to hang vertically on hangers - 36cm apart

DIMENSIONS

61cm x 173cm x 0.6cm

PRODUCT CODE	ITEM	PRICE
NTS-PM-V2-B	Pilates Mat (Blue) with Eyelets	£15.74
NTS-PM-V2-P	Pilates Mat (Purple) with Eyelets	£15.74



ORIGIN EVA FITNESS MAT

- EVA material is firm and lightweight - dense and foam-like
- 10mm thickness allows for a variety of uses
- Excellent cushioning properties
- Eyelets allow mats to hang vertically on hangers - 36cm apart

DIMENSIONS

95cm x 50cm x 1cm

PRODUCT CODE	ITEM	PRICE
NTS-EVAM-V1-GY	Origin EVA Mat - Grey	£10.49
NTS-EVAM-V1-BE	Origin EVA Mat - Blue	£10.49



ORIGIN TPE MAT

- Made from TPE material
- Boasts durability of plastic with comfortable sponge-like rubber feel
- 10mm thickness allows for a variety of uses
- Excellent cushioning properties
- Eyelets allow mats to hang vertically on hangers - 36cm apart

DIMENSIONS

95cm x 50cm x 1cm

PRODUCT CODE	ITEM	PRICE
NTS-TPEM-V1-GY	Origin TPE Mat - Grey	£14.00
NTS-TPEM-V1-BE	Origin TPE Mat - Blue	£14.00

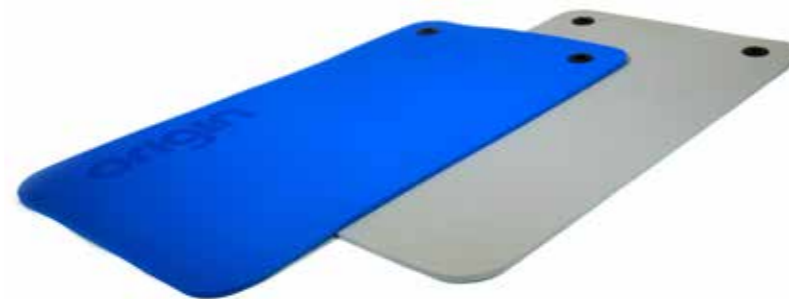

ORIGIN MAT HANGER

Simple effective design.

PRODUCT CODE	ITEM	PRICE
NTS-MATHANGER-V1	Origin Mat Hanger	£104.99



ORIGIN STRETCH MATS

Durable, versatile mats that can be used for balance, stretching and light floor exercises.

PRODUCT CODE	ITEM	PRICE
FS-SSM02-O-GY	Small Stretch Mat - Grey Dimensions 1200 x 700 x 25mm	£71.61
FS-SSM02-O-RD	Small Stretch Mat - Red Dimensions 1200 x 700 x 25mm	£71.61
FS-LSM01-O-GY	Large Stretch Mat - Grey Dimensions 2m x 1m x 25mm	£122.43
FS-LSM01-O-RD	Large Stretch Mat - Red Dimensions 2m x 1m x 25mm	£122.43



CENTRIC 3 TRIBES, CROUCH END, LONDON

- Impulse RT700 Treadmills
- Origin Pro Rubber Dumbbells
- Reebok Studio Steps
- PT4Pro Suspension Trainers

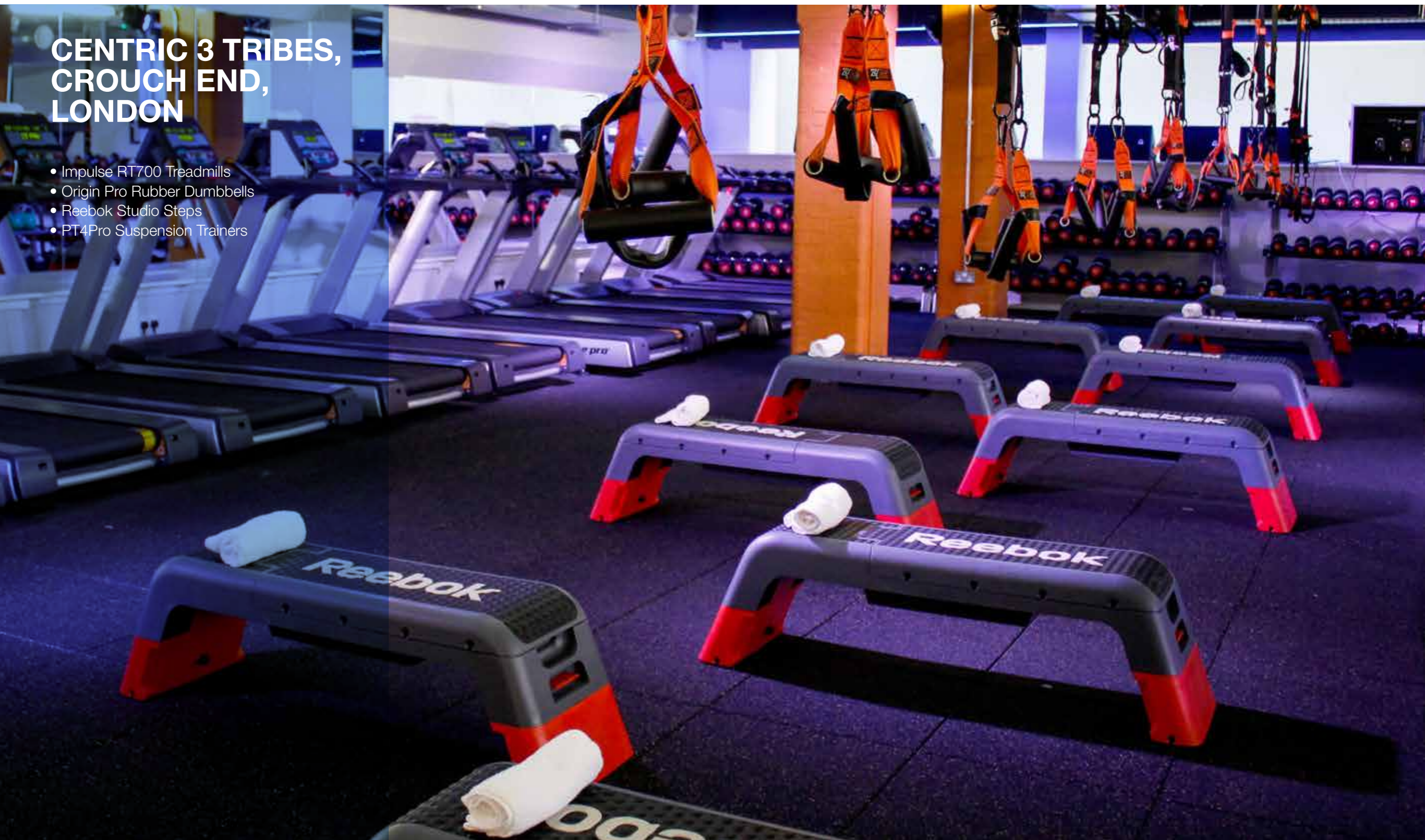

ORIGIN AEROBIC STEP

The Origin Aerobic Step is a great piece of commercial gym equipment for convenient, quick and effective workouts. A robust step, it is light enough to move around with ease and the perfect accessory for commercial or home use.

PRODUCT CODE	ITEM	PRICE
NTS-TS1448	Aerobic Steps Platform size: 1090mm x 420mm x 102mm Height adjustable 102mm - 152mm - 203mm	£73.37



REEBOK STUDIO STEP

The Reebok Step is perfect for a number of different fitness activities including cardiovascular training, lower body muscle toning and overall aerobic health.

PRODUCT CODE	ITEM	PRICE
D2F-RSP-10150	Reebok Studio Step Adjustable to 3 different heights (15cm/20cm/25cm)	£99.00



ORIGIN COMMERCIAL AIR BALANCE TRAINER

The Origin Commercial Air Balance Trainer is a unique balance, core stability and proprioception training tool which can be incorporated into any type of fitness training. It can also be used on it's own and still be an excellent piece of functional equipment.

PRODUCT CODE	ITEM	PRICE
NTS-TS1479	Origin Commercial Air Balance Trainer	£125.12



ORIGIN WOBBLE BOARD

The Origin Wobble Board (or balance board) is a great piece of equipment for balance, core strength and excellent for remedial work. The anti-slip top gives the user security on the balance area.

PRODUCT CODE	ITEM	PRICE
NTS-TS1510	Origin Wobble Board	£23.57



ORIGIN AIR BALANCE DISC

Ideal for balance, strength and rehab exercises, the Origin Air Balance Disc targets ankle, foot and knee stability. The user can increase or decrease the amount of air inside the disc to vary the stability of the cushion, and therefore the difficulty (less air makes the surface more unstable). Diameter 340mm, thickness 40mm.

PRODUCT CODE	ITEM	PRICE
NTS-TS-BC	Origin Air Balance Disc	£12.08



ORIGIN ANTI BURST GYM BALLS

The Origin Anti-Burst Gym Ball can be used for a variety of exercises that target core muscles and increase users stability, strength, balance and range of motion.

PRODUCT CODE	ITEM	PRICE
NTS-TS1202-55	Anti-burst 55cm Gym Ball (Blue)	£17.80
NTS-TS1202-65	Anti-burst 65m Gym Ball (Red)	£21.64
NTS-TS1202-75	Anti-burst 75cm Gym Ball (Silver)	£24.06
NTS-TS1202-55GN	Anti-burst 55cm Gym Ball (Green)	£16.18
NTS-TS1202-65GN	Anti-burst 65m Gym Ball (Green)	£19.68
NTS-TS1202-75GN	Anti-burst 75cm Gym Ball (Green)	£21.87



ORIGIN ANTI BURST GYM BALL SETS AND RACK

To help keep your gym or studio organised, the Origin gym ball rack is available in two sizes, one to accommodate three balls and another for six. The Origin Anti-Burst Gym Ball Set comprises of three different sizes of gym ball, including 55cm, 65cm and 75cm, and also comes with a three ball storage rack.

PRODUCT CODE	ITEM	PRICE
NTS-GBR-3	3 Gym Ball Rack (Silver)	£115.49
NTS-GB6R	6 Gym Ball Rack (Silver)	£178.05
NTS-GB3R	3 Gym Ball Set with Rack	£178.05



ORIGIN GYM BACK WALL RACK

- Keeps gym ball stable whilst exercising
- Stores gym ball when not in use
- Resistance tubes attached to dish provide extra workout options
- Made from durable plastic
- Holds up to 4 gym balls
- Wall fixings included
- Fix to secure wall

PRODUCT CODE	ITEM	PRICE
NTS-GBWR4-01	Gym Ball Wall Rack	£62.99



ORIGIN GYM BALL DISH

- Keeps gym ball stable whilst exercising
- Stores gym ball when not in use
- Resistance tubes attached to dish provide extra workout options
- Made from durable plastic

PRODUCT CODE	ITEM	PRICE
NTS-GBD-BK	Gym Ball Dish	£8.75



ORIGIN FOAM ROLLERS

The Origin Foam Rollers are manufactured from a dense foam material that is extremely lightweight, durable, and comfortable. Perfect for warm up, rehabilitation and self-myofascial release.

- Invaluable for rehabilitation
- Great for warm-ups & cool-downs
- Dense foam material keeps shape
- Comes in Short (46cm) and Long (95cm) lengths

DIMENSIONS

Diameter: 155mm

PRODUCT CODE	ITEM	PRICE
NTS-FR-SM	Small: 460mm long	£16.36
NTS-FR-LRG	Large: 950mm long	£28.86



ORIGIN FITNESS RESISTANCE BANDS

This is our lightest band and is ideal for those new to resistance training or for use in therapy and when recovering from injury.

PRODUCT CODE	ITEM	PRICE
NTS-TS1104-35	Origin Fitness: Resistance Bands (light)	£2.40
NTS-TS1104-50	Origin Fitness: Resistance Bands (medium)	£2.40
NTS-TS1104-65	Origin Fitness: Resistance Bands (strong)	£2.40



ORIGIN FITNESS RESISTANCE TUBES

Origin Resistance Tubes are light, portable and have padded handles for comfort providing an easy way to tone up at home, on holiday or on the go. Pack includes light, medium and strong bands (x 1 of each) plus 1 x pair padded handles.

PRODUCT CODE	ITEM	PRICE
NTS-TS1117	Origin Fitness: Resistance Tube Pack	£12.51



ORIGIN SPEED ROPES

The Origin Speed Rope is flawless in its design, perfectly balanced out weight provides an efficient workout. Performing unbeatable speeds due to the coated cable.

- Excellent for beginners - elite to enhance their footwork, endurance and over all skill
- Easily Adjustable to fit any height
- Coated Cable provides extra speed and durability
- Lighter handles with a heavier rope - provides a well balanced workout
- Bearings on each of the handles for easy and quick rotations

PRODUCT CODE	ITEM	PRICE
NTS-SPDSKIP-RD	Red	£9.16
NTS-SPDSKIP-BK	Black	£9.16



ORIGIN AB WHEEL

The Origin Ab Wheel focuses tension on the abdominal muscles when performing the roll out exercises, making it the ideal tool for strengthening the stomach and obliques. The Ab Wheel features two treaded wheels which provide stability, whilst the treads provide grip – preventing the wheels from slipping on smooth surfaces.

Foam handles provide extra grip and comfort for the user when performing the exercise. The Origin Ab Wheel is also extremely lightweight and easily transported.

- Two wheels provide stability
- Foam handles provides enhanced grip and comfort
- Lightweight - easily transported and stored away
- Treaded wheels to prevent wheel from slipping
- Lighter handles with a heavier rope - provides a well balanced workout
- Bearings on each of the handles for easy and quick rotations

PRODUCT CODE	ITEM	PRICE
NTS-ABWH-01	Ab Wheel	£14.99



BOXING EQUIPMENT

The Origin Boxing range uses the highest quality materials and manufacturers to offer the perfect set of tools for both sporting and fitness training.

Our gloves are made using GoDry material which improves ventilation and reduces perspiration.

Each product is made from the highest quality leather to ensure the entire range is hard wearing and comprise the perfect training tools.

[Mitts and Sparring Gloves](#)

[Hook & Jab Pads](#)

[Boxing Bags](#)

ORIGIN LEATHER BOXING MITTS

Origin Leather Boxing Mitts are perfect for all kinds of training and boxing workouts, although not suitable for sparring. Our priorities for the design of these gloves were maximum ventilation and flexibility without compromising on the quality of material not on the support offered during even the toughest of sessions.

- Ventilation holes in the upper part of the glove allows hands to breathe
- Made from the highest quality leather
- Thumb holed for extra flexibility
- Cutting edge GoDry ventilation material

PRODUCT CODE	ITEM	PRICE
PH(USD)-KBM-088	Small Leather Boxing Mitts (White)	£28.86
PH(USD)-KBM-089	Medium Leather Boxing Mitts (Grey)	£28.86
PH(USD)-KBM-090	Large Leather Boxing Mitts (Red)	£28.86
PH(USD)-KBM-091	Extra Large Leather Boxing Mitts (Black)	£28.86



ORIGIN LEATHER SPARRING GLOVES

Origin Boxing/Sparring gloves are manufactured from high quality leather, ensuring that they are built to last whether using them on the bag, pads or sparring sessions. Since gloves are regularly shared between users in fitness facilities, our special GoDry material has been used to increase ventilation and therefore reduce the build up of perspiration.

- Made from the highest quality leather
- Cutting edge GoDry ventilation material
- Air holes in upper half of glove that allows hands to breathe

PRODUCT CODE	ITEM	PRICE
PH(USD)-BAK-030	10oz Boxing/Sparring Gloves (White)	£34.64
PH(USD)-BAK-031	12oz Boxing/Sparring Gloves (Grey)	£34.64
PH(USD)-BAK-032	14oz Boxing/Sparring Gloves (Red)	£34.64
PH(USD)-BAK-033	16oz Boxing/Sparring Gloves (Black)	£34.64



SWIVEL HOOK

Ideal for attaching bags to ceiling for optimal training flexibility. Use the chain sets that come with the bag to hook on to the swivel, which helps reduce stress and wear on the bag straps themselves.

PRODUCT CODE	ITEM	PRICE
PH(USD)-KAC-367	Swivel Hook	£9.18



ORIGIN 1.25M ULTIMATE WALL BRACKET

If you're looking for a wall mounted boxing bag mount, the Origin 1.25m Ultimate Wall Bracket is for you. Strong and stylish, this bracket will hold your bag in place punch after punch.

- Maximum load of 150kg
- Suitable for commercial and home use.
- 100mm x 50mm box section steel constructed.
- Slotted holes for uneven wall surfaces.
- Epoxy powder coated complete with all fixings.

PRODUCT CODE	ITEM	PRICE
OF-7147	Origin 1.25m Ultimate Wall Bracket	£169.99



ORIGIN HOOK & JAB PADS

Our Origin Fitness Hook & Jab Pads are perfect for training in a boxing, martial arts gym or in small gyms, PT studios, or bootcamps.

- Absorbs shock with a lightweight design
- Made from the highest quality leather
- Curved design allows upper cuts, jabs, and hooks with great grip

PRODUCT CODE	ITEM	PRICE
PH(USD)-CMK-051	Hook & Jab Pads (One Size)	£46.19



ORIGIN 4 STATION BOXING FRAMES

This heavy-duty steel frame allows a group of four to conveniently perform boxing circuits. The free-standing frame requires no additional fixings so it's easy to move around your training facility. Manufactured in the UK to withstand even the toughest of treatment in professional surroundings. Complete with an epoxy powder coated finish for extreme durability. A choice of frame colours is available.

- Can be used by four people simultaneously
- Consists of three hanging bag stations and one speed ball station
- Floor fixing plate available but can also be used free standing
- Heavy duty 100x100mm box section construction
- Epoxy powder coated finish for extreme durability and quality

PRODUCT CODE	ITEM	PRICE
OF-7000	Origin 4 Station Boxing Frame (inc Speedball Platform)	£1,192.00
OF-7001	Origin 4 Station Boxing Frame (4 Bag Arms)	£1,192.00

ORIGIN 3FT BOXING WALL BRACKET

Designed to take a punch – our 3ft Wall Mounted Boxing Bracket is designed to take even the largest and heaviest punch bags. Constructed from box sectioned steel and with slotted mounting holes, this bracket will hold any bag against any wall.

This boxing bag is ideal for home or intense commercial use and holds the bag at a distance of just under 1m away from the wall.

- Designed to take the largest of punch bags.
- Suitable for commercial and home use.
- 100 x 50 box section steel constructed.
- Slotted holes for uneven wall surfaces.
- Epoxy powder coated Complete with all fixings.

PRODUCT CODE	ITEM	PRICE
OF-7140	Origin 3ft Club Pro Folding Wall Bracket	£74.96



O'LIVE ELITE FREESTANDING PUNCHBAG

The O'Live Elite Freestanding punching bag is built to last; it is constructed for commercial use and with the user in mind. It is made entirely from foam rubber. The donut shaped foam base is stronger and more shock absorbent than plastic, providing extra user safety. The vertical tube is also fabricated completely from foam rubber and includes an antibacterial covering.

- Built to last
- For commercial use
- Completely made of foam rubber
- Stronger and more shock absorbent than plastic
- Anti-bacterial covering



PRODUCT CODE	ITEM	PRICE
AAF-FI04600	O'live Elite Freestanding Punchbag	£921.11

ORIGIN FUNCTIONAL RIG BOXING STATION

(EXCLUDES BOXING BAG)

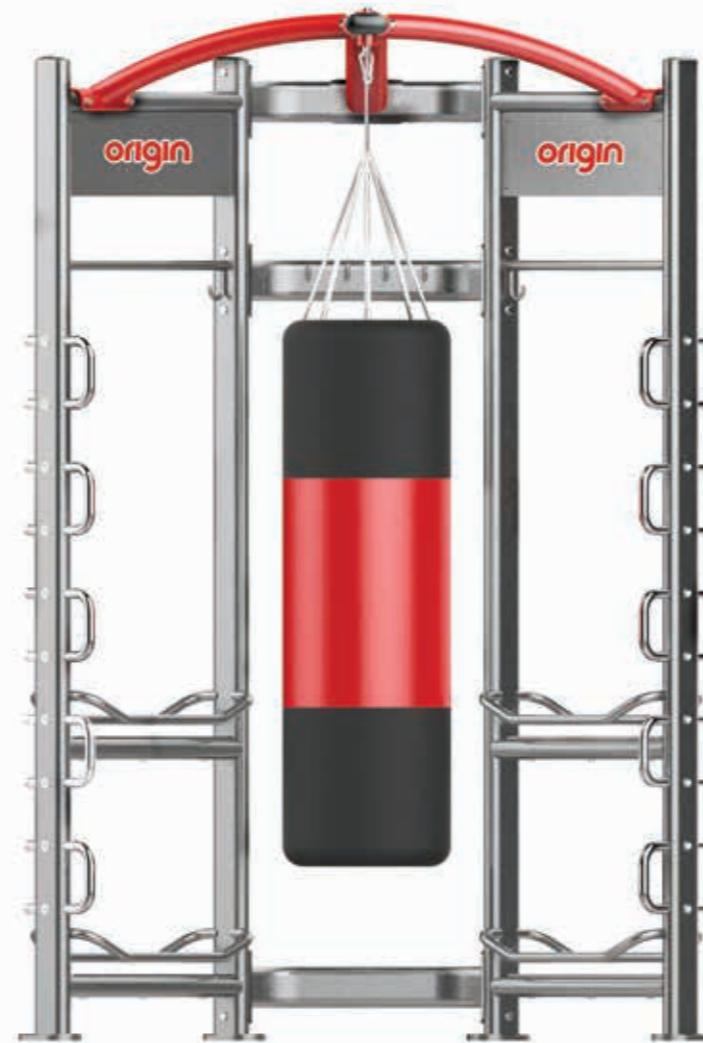

PRODUCT CODE	ITEM	PRICE
IF-OF-IZ7002	Functional Rig - Boxing Station (excludes boxing bag) 1655mm x 1126mm x 2377mm Weight 135.9kg	£1,924.03

ORIGIN LEATHER PUNCH BAGS

Perhaps the most exciting addition to the Origin Boxing range is the Leather Punch Bag. This comes in various heights and with hanging chains for attaching to the ceiling or a training rig.

- Hard wearing leather outer layer
- Chains give added stability
- Can hook to the ceiling, functional rig or wall bracket
- Promotes fitness on multiple levels

PRODUCT CODE	ITEM	PRICE
PH(USD)- KPB-207-100-30	3.3ft Leather Punch Bag 100x30cm Weight 28kg	£115.50
PH(USD)- KPB-207-120-35	4ft Leather Punch Bag 120x35cm Weight 44kg	£138.60
PH(USD)- KPB-207-150-35	5ft Leather Punch Bag 150x35cm Weight 50kg	£173.25
PH(USD)- KPB-207-180-35	6ft Leather Punch Bag 180x35cm Weight 56kg	£184.80



FLOORING

Fitness flooring is a speciality not dissimilar to the specification of the free weights, cardio or functional zone and must be considered as part of the early planning of a space when identifying each zone within the gym.

Gym flooring is a crucial part of any successful gym fit out and is often not given the necessary consideration. Fitness flooring is a speciality like the specification of the free weights, cardio or functional zone and needs to be part of the early planning of the space when considering the space allocation for each zone within the gym.

Origin flooring products are versatile and can be used in a variety of different environments:

- Free Weights
- Strength and Conditioning
- Cardiovascular
- Functional
- Studio

Fitness Flooring

Sprint and Sled Tracks



CARDIO

STRENGTH

FREE WEIGHTS

RIGS & STORAGE

FUNCTIONAL

STUDIO

BOXING

FLOORING

GYM DESIGN

SUPPORT



ORIGIN PREMIUM 20MM FITNESS TILE

The Origin Premium Fitness tiles are highly durable, resilient, slip resistant rubber tiles that are suitable for all kinds of areas including general fitness, light free weight, functional and CrossFit areas.

The 20mm tiles are a cost effective solution to gym flooring, and are easily installed. These tiles will reduce noise and vibrations as well as absorb light impact from equipment.

PRODUCT CODE	ITEM	SOLD AS	THICKNESS
OF-CY-PFT20	Call for a quote and colour details	1m x 0.5m Tiles	20mm

ORIGIN HIGH IMPACT TILE (40MM)

The Origin High Impact Tile is a prefabricated rubber tile composed of a 3mm EPDM rubber top surface and is supported by a recycled rubber base layer. These tiles are ideal for free weight areas, but can be used in any gym situation.

These tiles have excellent impact absorption as well as sound and vibration reduction.

PRODUCT CODE	ITEM	SOLD AS	THICKNESS
OF-CY-HI40	Call for a quote and colour details	1m x 0.5m Tiles	40mm

COLOUR OPTIONS

BLACK WITH COLOUR FLECK
(15% SOLID COLOUR EPDM RUBBER)

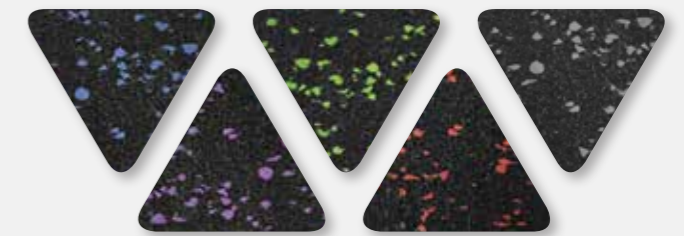

Other colours are available on request, however incur an extended lead time.



GYM DIVISION FLOORING

Gym Division fitness flooring is a great value flooring option for commercial fitness facilities. These homogenous (single layer) SBR rubber tiles offer the perfect solution for medium footfall spaces where the sub floor or usage dictates a requirement for a protective layer between the sub-floor and user.

PRODUCT CODE	ITEM	SOLD AS	THICKNESS
GD-FT20	Floor Tile 20mm	1m x 1m	20mm
GD-HI40	High Impact Tile 40mm	1m x 1m	40mm

ORIGIN PREMIUM 10MM FITNESS ROLL

The Origin Premium Fitness Rolls are highly durable, resilient, slip resistant rubber rolls that are suitable for all kinds of areas including general fitness, light free weight, functional and cross fitness areas.

The 10mm Fitness Rolls are a cost effective solution to gym flooring, and are easily installed. These rolls will reduce noise and vibrations as well as absorb light impact from equipment.

The rolls are made from 85% recycled rubber and 15% coloured EPDM granules and has no top sheet.

PRODUCT CODE	ITEM	SOLD AS	THICKNESS
OF-CY-FR10	Call for a quote and colour details	1.25m x 10m	10mm

COLOUR OPTIONS

BLACK WITH COLOUR FLECK
(15% SOLID COLOUR EPDM RUBBER)

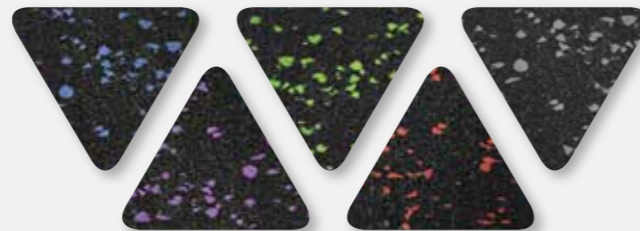

Other colours are available on request, however incur an extended lead time.

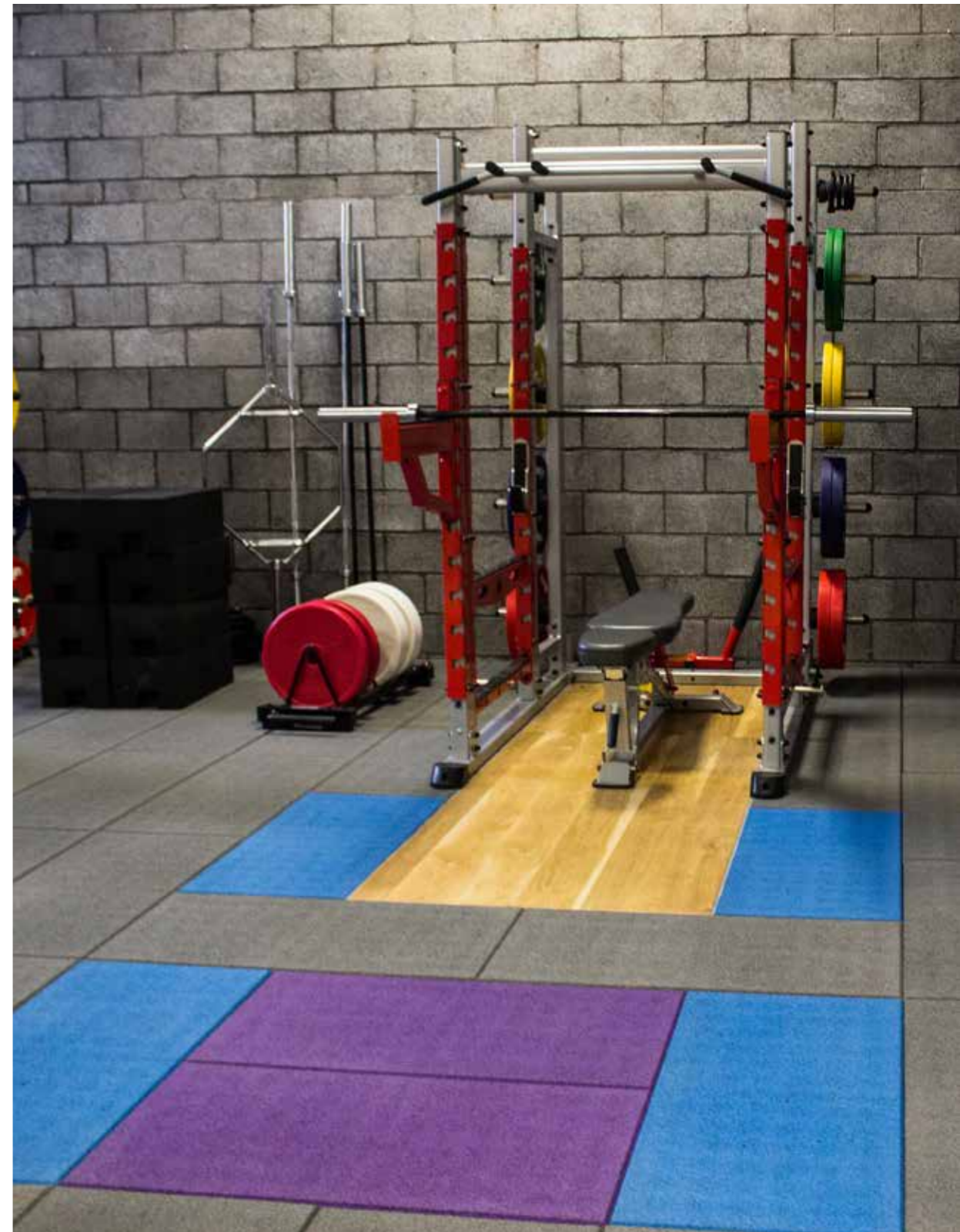

ORIGIN 10MM RUBBER INTERLOCKING TILE

The Origin 10mm Rubber Interlocking Gym Floor Tile is an ideal flooring solution for home and gym use. Slightly more hard wearing than the EVA equivalent, these tiles will protect your floor from damage and any marks that might be made.

20MM RUBBER FREE WEIGHT INTERLOCKING TILE

The Freeweight Mat is a super-tough, 100% solid rubber interlocking mat. It protects floors from heavy weights and equipment - and offers great sound insulation. Each mat measures 102cm x 102cm square with a depth of 20mm.

- Super tough, heavy duty
- 100% solid rubber
- Anti-slip surface
- Fully interlocking
- Sound insulating
- Edges and corners available



PRODUCT CODE	SOLD AS	THICKNESS	PRICE
NTS-BRT10	0.5m x 0.5m	10mm	£12.08
NTS-BRT10-C	Corner	10mm	£2.63
NTS-BRT10-E	Edge	10mm	£4.99

PRODUCT CODE	SOLD AS	THICKNESS	PRICE
OF-FL-JTW-T	102cm x 102cm	20mm	£73.36
OF-FL-JTW-C	Corner	20mm	£5.59
OF-FL-JTW-E	Edge	20mm	£21.21

20MM FIRM EVA INTERLOCKING TILE

Firm EVA Interlocking Tiles are dual density EVA mats used by leading gyms and health clubs in the UK. Each mat measures 102cm x 102cm square with a depth of 20mm.

- Dual density
- Lightweight
- Anti-slip surface
- Fully interlocking
- Wide choice of colours
- Wipe clean
- Edges and corners available

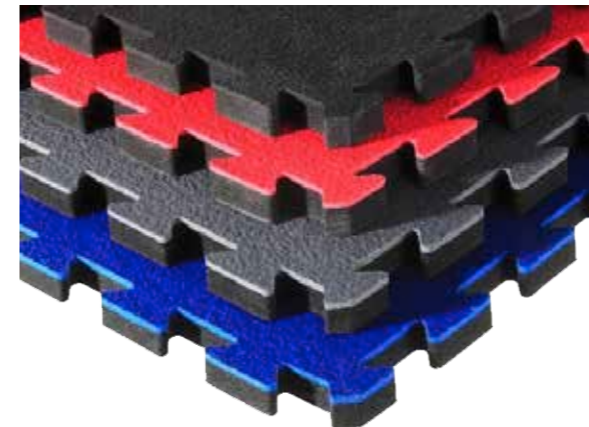

PRODUCT CODE	SOLD AS	THICKNESS	PRICE
OF-FL-JTF-T	102cm x 102cm	20mm	£71.40
OF-FL-JTF-C	Corner	20mm	£5.25
OF-FL-JTF-E	Edge	20mm	£21.21

20MM SOFT EVA INTERLOCKING TILE

Soft EVA Interlocking Tiles are lightweight EVA mats used by leading gyms and health clubs in the UK. Each mat measures 102cm x 102cm square with a depth of 20mm.

- Soft
- Lightweight
- Anti-slip surface
- Fully interlocking
- Wide choice of colours
- Wipe clean
- Edges and corners available

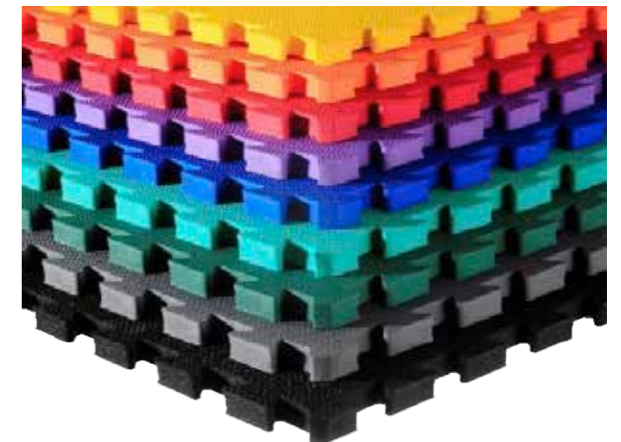

PRODUCT CODE	SOLD AS	THICKNESS	PRICE
OF-FL-JTS-T	102cm x 102cm	20mm	£60.24
OF-FL-JTS-C	Corner	20mm	£4.46
OF-FL-JTS-E	Edge	20mm	£20.08

ORIGIN SPRINT TRACK – SPORTS CARPET

Perfect for indoor performance sprint tracks, sled tracks and functional fitness purposes. The Origin Sprint Track Sports Carpet is made from dense, texturised, monofilament polyethylene blades. Line markings come as standard and in various colour options.

PRODUCT CODE	ITEM	WIDTH	LENGTH
OF-ST10	Track with Lines	1.5m	10m
OF-ST10-2	Track with Lines	2m	10m
OF-ST15	Track with Lines	1.5m	15m
OF-ST15-2	Track with Lines	2m	15m
OF-ST20	Track with Lines	1.5m	20m
OF-ST20-2	Track with Lines	2m	20m

Available Colours: Blue, Dark Green, Light Green, Terracotta, Bright Red, Yellow

Line colours: Blue, Red, White, Black, Yellow

ORIGIN SPRINT TRACK TURF

Our Sprint Track Turf is an ideal choice for sled and sprint tracks and offers high performance and durability for gyms of all types.

PRODUCT CODE	ITEM	WIDTH	LENGTH
PR-STT	Call for quote	4m	10m
PR-STT	Call for quote	2m	10m

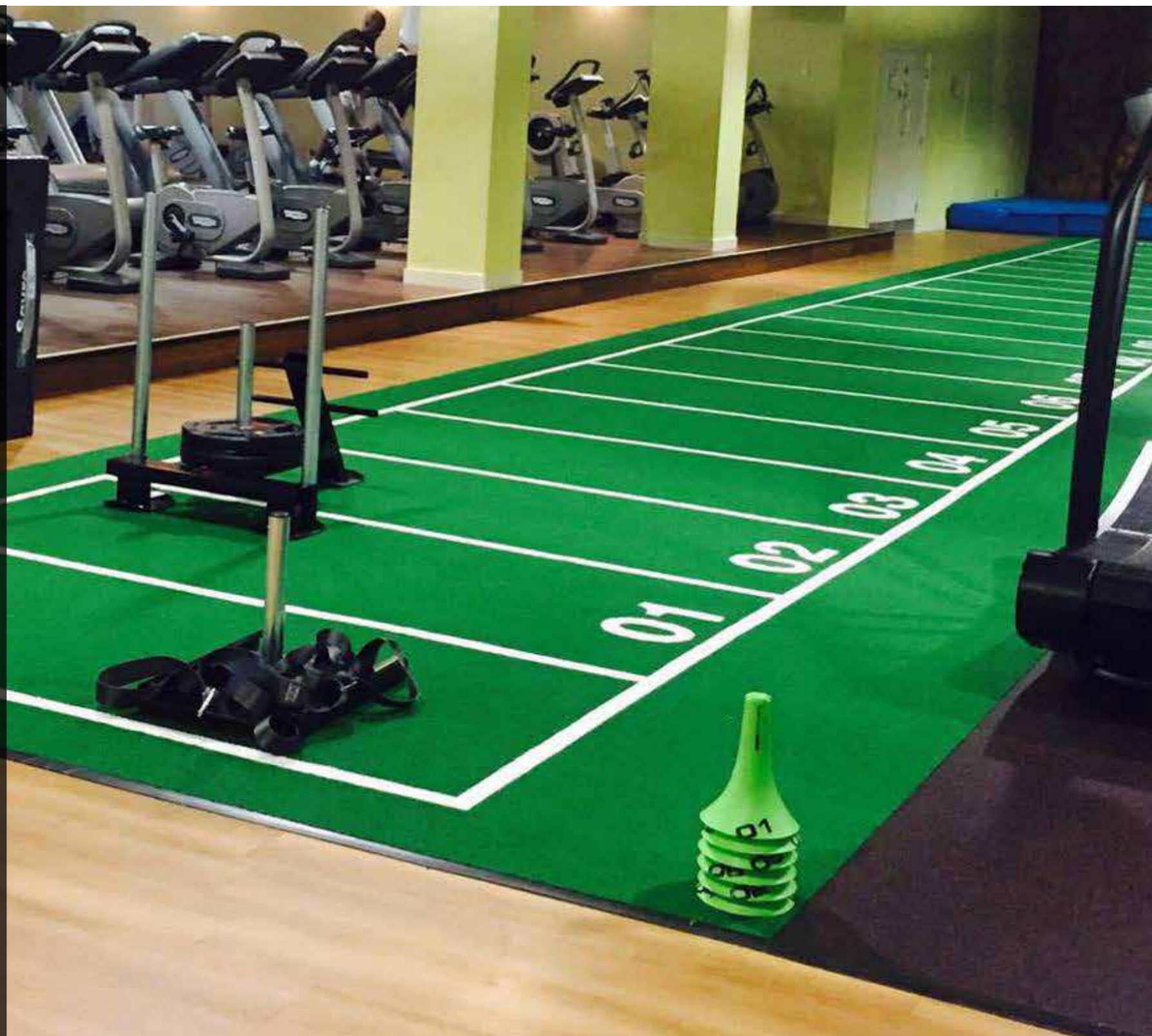

GYM DESIGN

Origin Fitness offers high quality, bespoke gym design solutions. We apply our gym design principles across the board, from personal trainer studios to independent clubs, local authorities to hotels, and sports clubs to CrossFit boxes.

With a wealth of experience, we are able to call upon different experts from within our team depending on your specific requirements. This allows us to provide an individually tailored proposal and an exceptional gym design service from start to finish.

[Design Service](#)

[Case Studies](#)





Nuffield Health, Club Baltimore

“EACH PROJECT IS TREATED ON AN INDIVIDUAL BASIS. THE CLIENTS WILL DISCUSS THE BRIEF AND THE TYPE OF GYM THEY HAVE OR ARE THINKING OF HAVING”

To begin with we'll have an initial consultation to help us understand your objectives. The design process starts with a complete understanding of what type of facility you want to create, the USPs that your business is built upon and an even better understanding of the target customer who's going to use the space.

In order to create the perfect training space our experienced designers will advise on layout, interiors, flooring and finishes, as well as guiding you to your final choice in fitness equipment.

We can help you visualise your project using 3D designs and 360° video walkthroughs using the latest software and VR headsets.

Once you're happy with plans we'll put the wheels in motion to have our team of experts prepare the site for installation, train your staff on equipment and help put together marketing plans all before the final installation.

Equipment and Zoning

- Understanding the activity that goes on at a client facility helps us to create zoned layouts which maximise the use of every square foot, ensuring we create a safe, friendly and exciting gym environment.
- We will recommend equipment from our industry leading range of brands for these zones based on the type of gym user, type of training activity and budget.

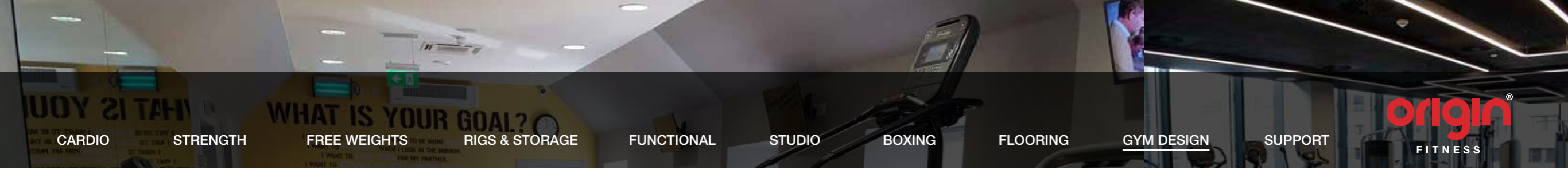

Flooring

- Flooring is crucial, for ensuring the longevity of a gym’s equipment and protecting the fabric of your building.
- As well as functionality being a huge driver in flooring choice, the design element has become increasingly important with custom branding, designs, colours and markings being featured in many of our gym designs.

Interior Design

- The look and feel of a gym can be influenced greatly by the interior design, mirrors, artwork and use of lighting to create the desired ambience.
- One popular service Origin Fitness offers is the design and creation of full wall graphics and wall vinyls such as Tour de France images in cycling studios and motivational quotes on PT studio mirrors.

Branding and Signage

- Ensuring the different zones within a gym are clearly signposted and making clear the rules and requirements for both safe and friendly facility use, can go a long way in creating the kind of gym you want.
- As well as gym signage, Origin Fitness can provide workout posters to guide members around their workout when a trainer is not immediately available.

Design and Planning

- From the initial meeting, Origin Fitness will appoint a dedicated sales manager who will listen and understand your vision while offering advice and guidance. We will then recommend the products and services which you can use to bring this vision to life.
- To help visualise the facility, we will create 2D plans and 3D designs to aid your decision making. We can even create 3D walk through videos to help with your project proposals and pre-launch promotion.

THE FITNESS EXPERTS HIGH WYCOMBE

“

Over the past two years we've worked closely with Origin Fitness to develop the design and plan for our most recent facility in High Wycombe. Origin Fitness set themselves apart from the competition by giving us an incredibly personal and supportive service right from the initial planning and design stage. They approached the project with the same patience and attention-to-detail that we did ourselves. Being able to work with a single point of contact to deliver all aspects of the project from flooring to equipment supply made things very easy for us. We'd definitely be happy to recommend Origin Fitness and we look forward to working with them again in future.

Tom Edwards
The Fitness Experts

”

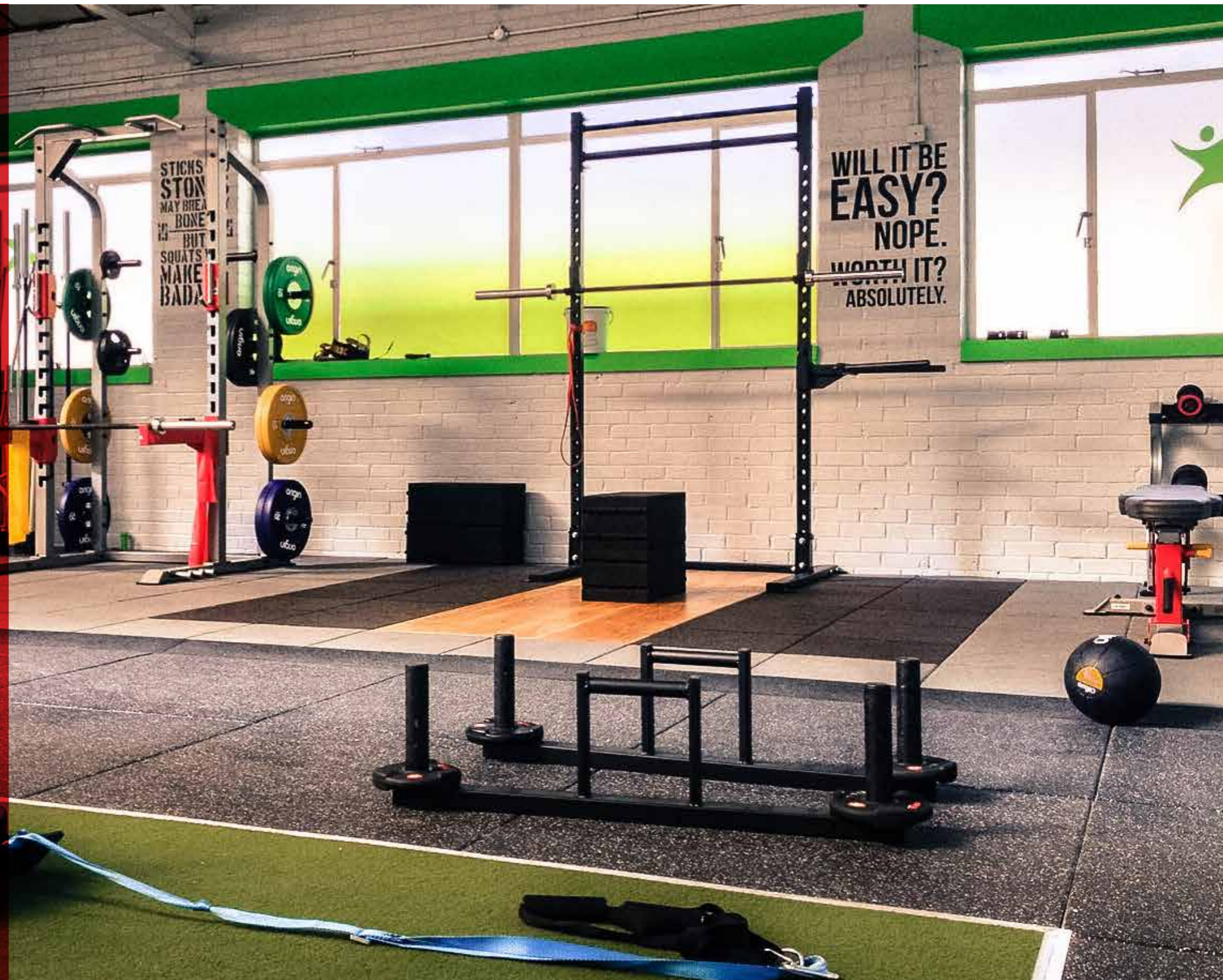

GYMBO'S HEALTH AND FITNESS



When first embarking on this project, I could not have predicted the huge role Origin Fitness ended up playing in the completion of my facility. Unlike some of their other customers, I had a very clear vision of what I wanted to achieve, and Matt worked with me to make this vision a reality. Origin Fitness provided all the equipment at a very competitive price, and I am very pleased with the work they have done. I would definitely recommend them to anyone looking to set up a new facility.

James Rivers
Owner

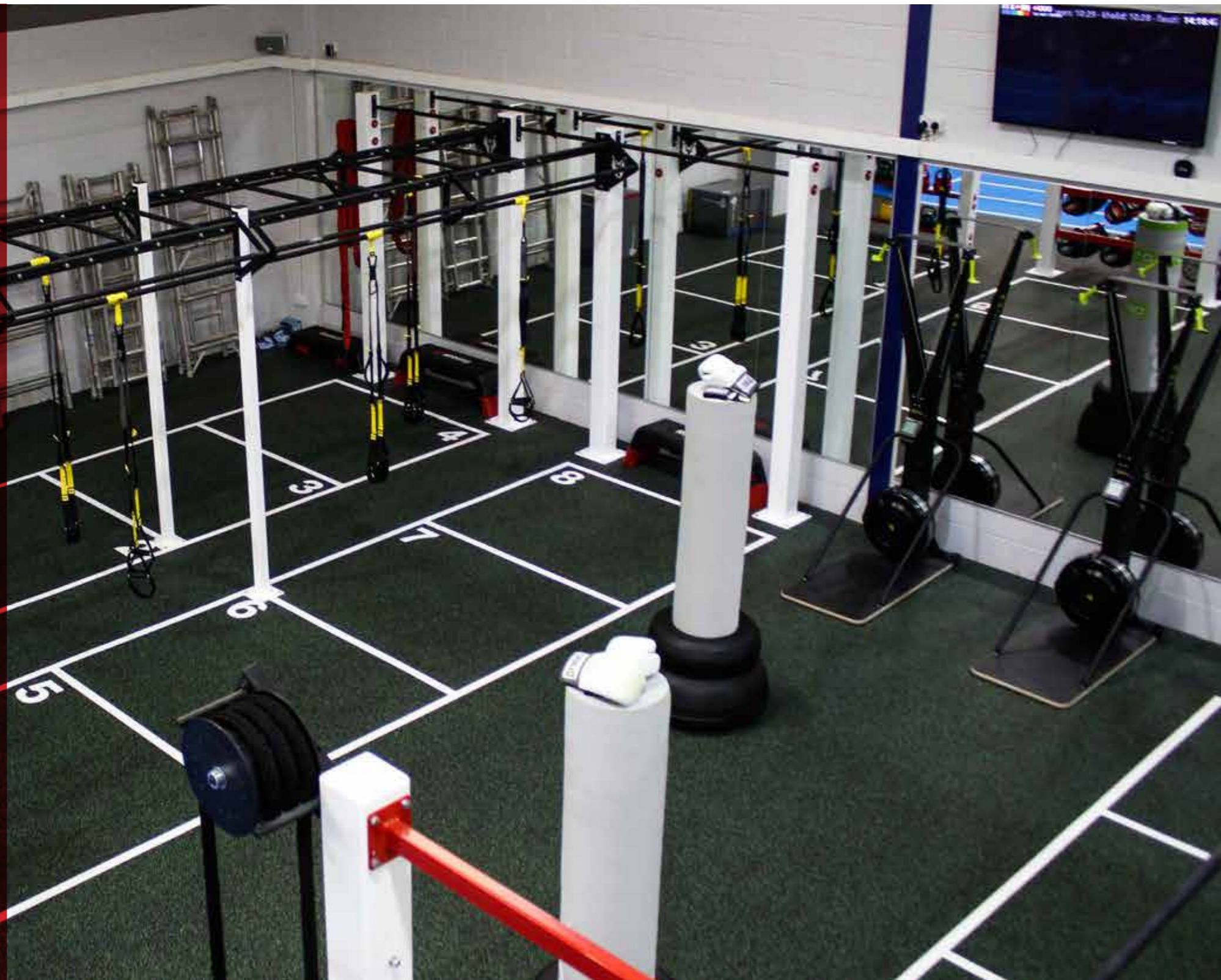

NORTH LANARKSHIRE LEISURE WISHAW

“

We are delighted to be working in partnership with Origin Fitness to roll out our next generation of gym installations that will help us remain at the forefront of the health and fitness sector. Origin Fitness understands that the changing patterns of public demand mean industry trends are moving towards new and traditional functional and resistance training methods.

Nichola McLachlan
Fitness Development Manager
North Lanarkshire Leisure

”



GB TAEKWONDO NATIONAL TRAINING CENTRE



“

Working with Origin Fitness has been extremely positive from the outset, with clear communication lines and a commitment to deliver what was needed to meet our objectives, irrespective of the hurdles presented by operating within a live construction site.

Steve Flynn
Operations Director
GB Taekwondo

”

NUFFIELD HEALTH SITES ACROSS THE UK

“

We are pleased to be working with Origin Fitness as our fitness accessory provider. We feel that they provide the best service in terms of value and quality and look forward to seeing their products across the estate.

Rick Crawford
Fitness Director
Nuffield Health

”



ANYTIME FITNESS UK

“

We are delighted to have so many of our franchises choosing to install Origin Fitness equipment to enhance their offering to members. They are great to deal with on a day to day basis and always go the extra mile to give great service.

”

Eliza Archer
Franchise Consultant
Anytime Fitness UK

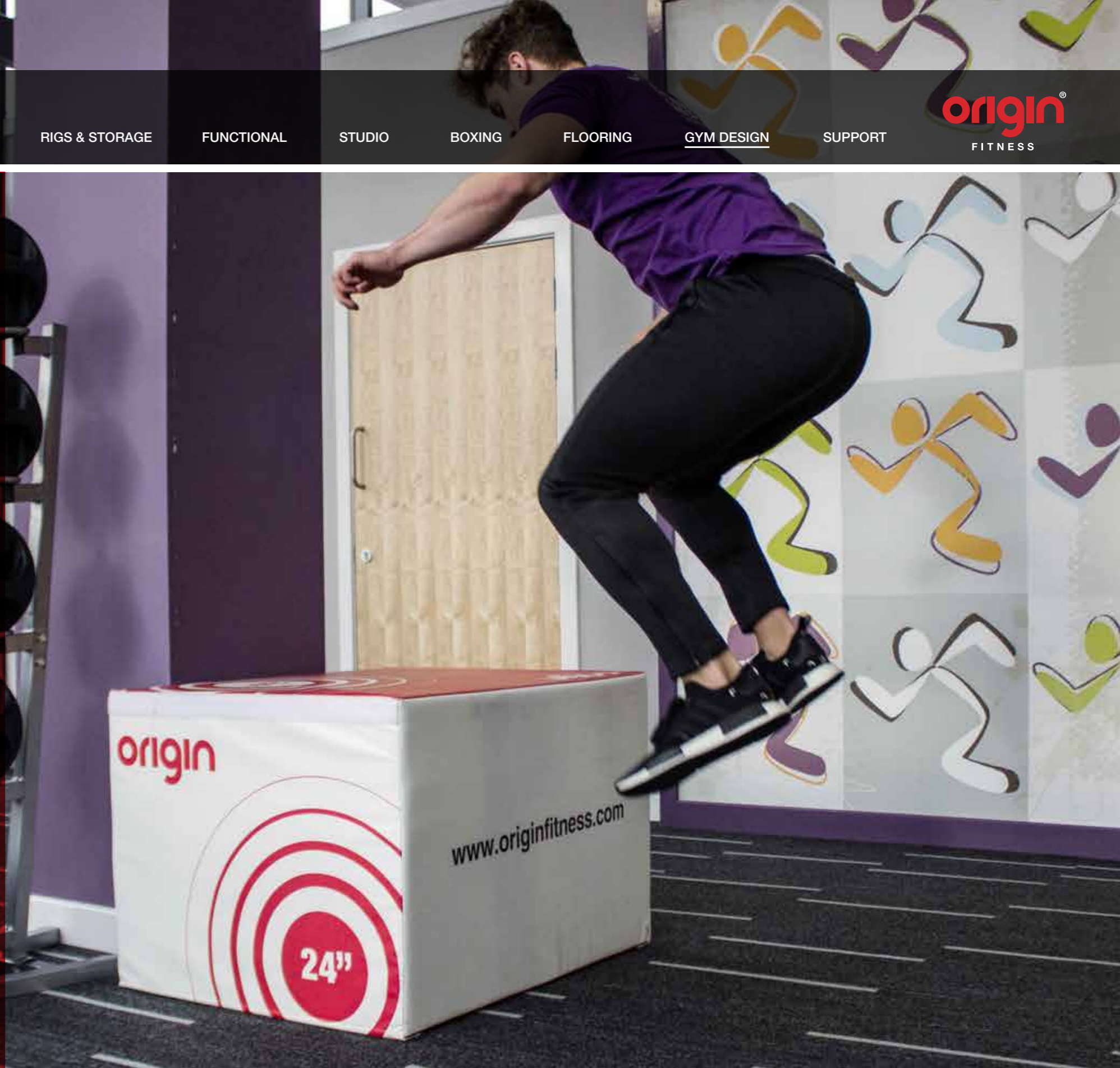

WHO WE WORK WITH

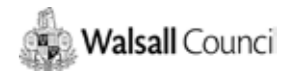

SUPPORT

Origin Fitness is proud to offer customers a complete service which extends beyond gym design and equipment supply. Our goal is to help your fitness business be as successful as possible. In order to achieve this we have in-house teams dedicated to supporting your business with training and education, equipment servicing and maintenance as well as business support and marketing services.

Training

Marketing

Service

TRAINING

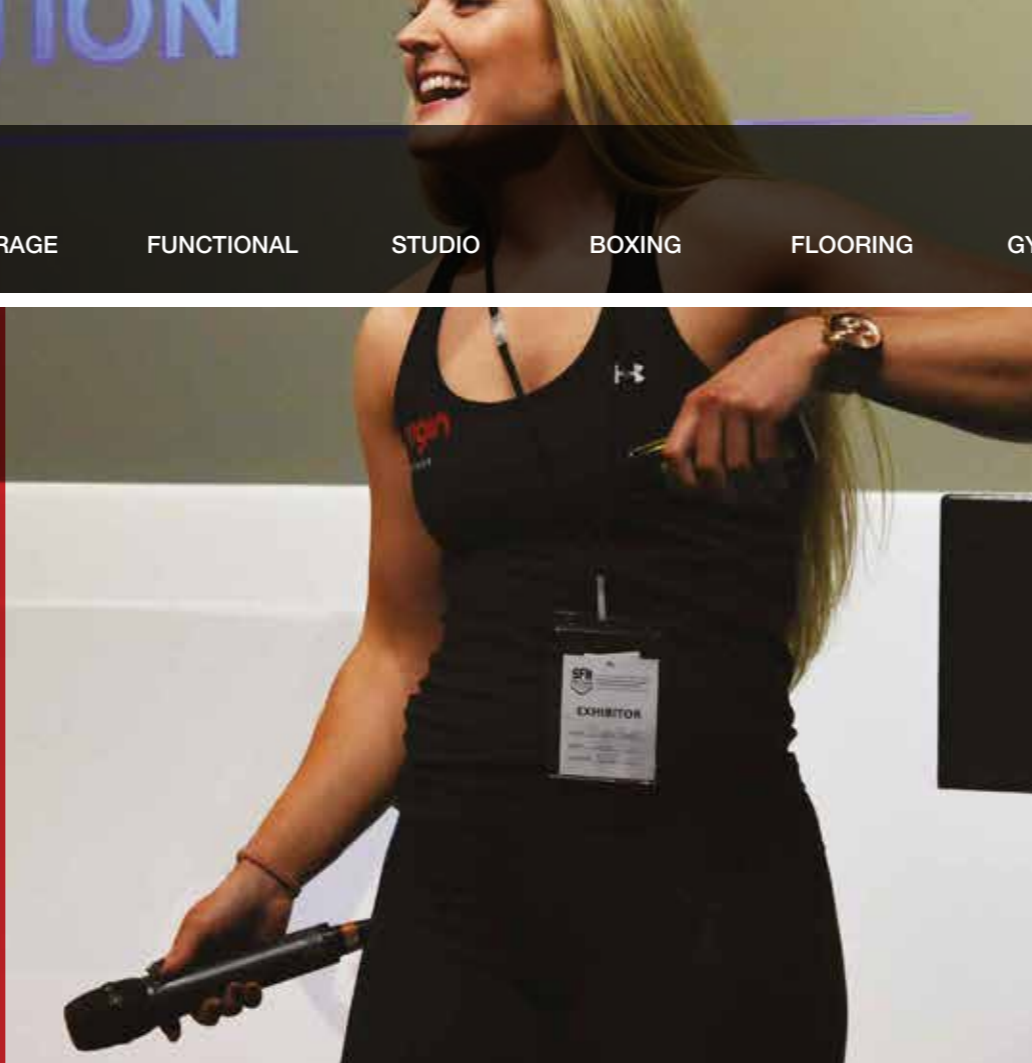

How can we help you?

The Training Academy offers a comprehensive range of course types and delivery formats to ensure our wide range of courses are accessible to everyone. Our Edinburgh venue is quickly becoming a hub for fitness education in Scotland with courses running almost every week.

Tailored to your needs

Our courses can accommodate individuals looking to develop their knowledge, as well as leisure industry operators looking to enrol a group of staff on a course that will support and enhance their service and standard of training.

In-house Training

For larger operators, in-house training courses can be delivered bespoke to meet your service needs and goals. We can bring along specific equipment required on the day and be ready to deliver high quality courses for your staff and team.

Applicable Knowledge

All our courses are developed to ensure that attendees can start returning the training investment from day one. Each course is accompanied by the appropriate manuals, teaching materials and downloads.

Use Our First Class Facilities

The main gym within our Training Academy is equipped to the highest standard to make sure the learning experience you receive as a course participant is not just good, but exceptional.

The Training Academy replicates the areas you will find in any commercial gym; the free weights zone, fixed resistance machines, cycling studio, cardio zone, a fully equipped functional training rig and flexible studio space. This, combined with two seminar rooms, screens and projectors, makes it the ideal venue for courses and workshops.

Education Partnerships

For 2017 we are pleased to announce a partnership with British Weightlifting (BWL). The partnership between us is one that BWL feels will ensure coaching and education products are delivered to a very high standard across a whole range of industry providers. With a variety of courses available throughout the year for all standards, we can be sure to meet the needs of our customers across all sectors.

REPs Endorsed Origin Fitness Courses

- Functional Training
- Sandbag Instructor
- Olympic Weightlifting Coach
- Kettlebells Instructor
- Advanced Kettlebells Progressions
- Self Myofacial Release

MARKETING

Origin Fitness is committed to working in partnership with our customers and we are proud to have a strong focus on helping our clients grow, develop and succeed in providing the best service possible to more members than ever.

Origin's marketing support services can be distinguished into two areas:

Consultancy

Our consultancy services include gym design, business planning, sales and marketing strategies, service delivery training and campaign planning. To deliver these we use a carefully selected team of industry experts whose extensive experience is sure to add value to your business.

Branding & Design

Our branding and design services include custom branding on equipment, signage, interiors and other marketing materials. Using our in-house team and expert partners, we can provide solutions to meet all of your branding and design requirements.

SERVICE

Origin Fitness is proud to provide service through our own qualified service engineers who work in partnership with an extensive network of independent engineers on behalf of the brands we supply. With engineers across the UK the company can offer support seven days a week, enabling a guaranteed 48 hour response time to any service request. At Origin Fitness we are committed to maintaining an exceptional level of service across all areas of our operations. This is why we are the only UK fitness equipment company to invest in three internationally recognised accreditations; ISO9001 (Quality Management Systems), ISO14001 (Environmental Management Systems) and ISO18001 (Occupational Health and Safety Management).

Our in house team of engineers and technicians look after installations, equipment servicing, maintenance and refurbishment. We have a central warehouse located in Edinburgh, which holds parts at all times for current ranges and also for the previous two generations of each piece of equipment we sell. An inventory of parts is also kept with the service engineers which allows for a more effective call out response and also higher first time fix rates.

Origin Fitness will ensure an engineer is on site within 48 business hours of a fault being logged. We have an average response time within 24 hours and boast a first time fix rate of 98%.

